

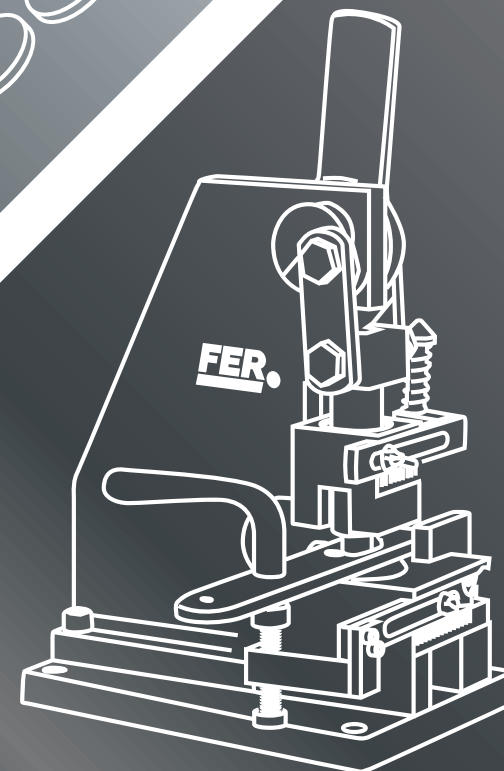

# CATÁLOGO TARIFA 2022-2023

TORNILLERÍA / QUINCALLERÍA / MÁQUINAS BOCALLAVES

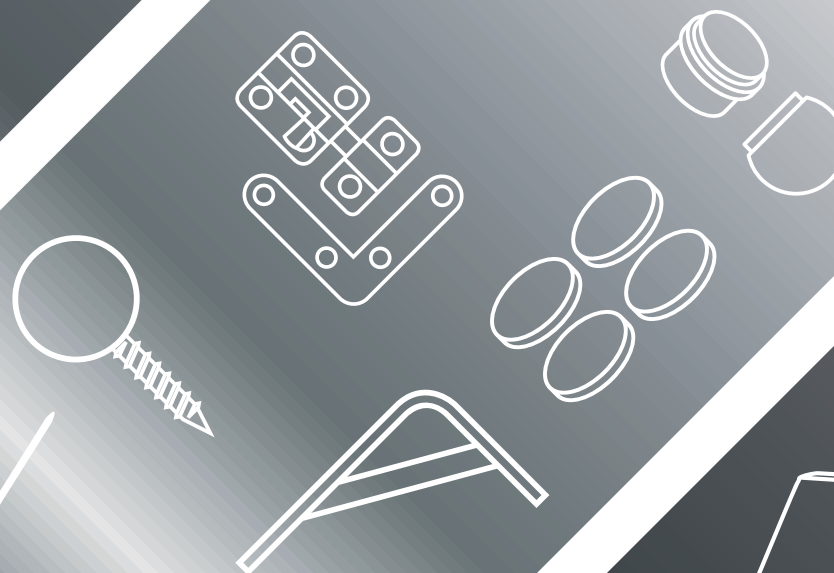

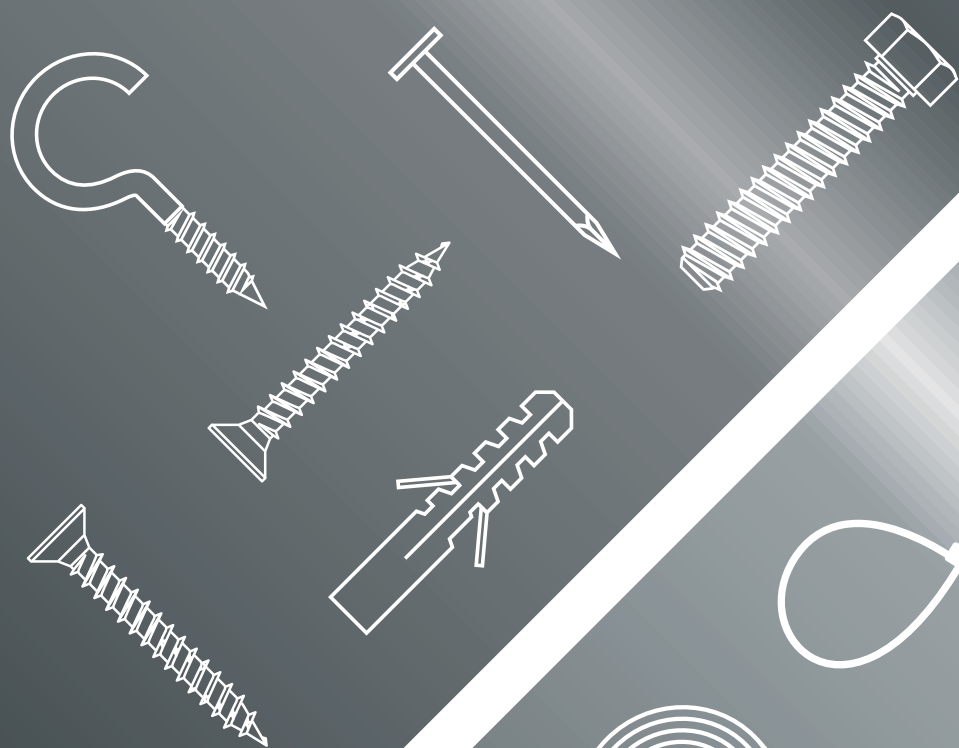

[www.industriasfer.com](http://www.industriasfer.com)



**VISITA NUESTRO  
CATÁLOGO ONLINE**

CONSULTEZ NOTRE CATALOGUE EN LIGNE  
CONSULT OUR ONLINE CATALOGUE



**VISUALIZA NUESTRO  
VÍDEO DE PRESENTACIÓN**

VISUALISEZ NOTRE VIDÉO DE PRÉSENTATION  
DISPLAY OUR INTRODUCTORY VIDEO

SEDE CENTRAL / SIÈGE CENTRAL / HEAD OFFICE



ES

**FER** es una empresa fundada en 1969 que, actualmente, cuenta con un equipo humano compuesto por más de 70 personas.

Desarrollamos producto junto a diversos colaboradores, anticipándonos a las necesidades del mercado y lo importamos, envasándolo en nuestras plantas especializadas y distribuyéndolo a los puntos de venta y almacenes del Canal Tradicional, Mayoristas de Ferretería, Carpintería y Electricidad, Grandes Superficies de Bricolaje y Grandes Superficies de Alimentación.

Presentamos en este catálogo nuestras tres líneas principales de negocio: Tornillería, Quincallería y Máquinas Bocallaves.

Ponemos a disposición de nuestros clientes altos niveles de versatilidad y adaptabilidad, que posibilitan la entrega de producto en diferentes tipos de envase (cajas de plástico y cartón, skin pack, blíster de alta frecuencia, bolsas, etc.) en cortos espacios de tiempo.

✓ **Más de 9.000 referencias.**

✓ **Servicio de envasado a medida en instalaciones propias.**

✓ **Almacén inteligente automatizado de 21.000 ubicaciones con posibilidad de picking en el carro, lo que acorta sustancialmente los tiempos de preparación y expedición.**

✓ **Servicio de entrega en 48 - 72 horas.**

ENVASADO DE PRODUCTO / EMBALLAGE DE PRODUIT / PRODUCT PACKAGING



FR

**FER** est une entreprise fondée en 1969, qui compte actuellement une équipe de travail composée de plus de 70 personnes.

Nous développons notre produit avec l'aide de différents collaborateurs, en anticipant les besoins du marché et nous l'importons, l'emballons dans nos usines spécialisées et le distribuons aux points de vente et magasins du circuit traditionnel, aux grossistes en quincaillerie, menuiserie et électricité, aux grandes surfaces de bricolage et grandes surfaces alimentaires.

Nous présentons dans ce catalogue nos trois principaux secteurs d'activité : Visserie, Quincaillerie et Presses à découper pour trous de serrure.

Nous proposons à nos clients un niveau de polyvalence et d'adaptabilité élevé, qui permet de livrer le produit dans différents types d'emballage (caisses en plastique ou carton, pelliculage, emballage blister de haute fréquence, sacs, etc.) dans des délais courts.

- ✓ **Plus de 9 000 références.**
- ✓ **Service d'emballage sur mesure dans nos installations.**
- ✓ **Entrepôt intelligent automatisé de 21 000 emplacements avec capacité de retrait depuis le chariot, ce qui réduit les temps de préparation et d'envoi.**
- ✓ **Service de livraison en 48 - 72 heures.**

ALMACÉN AUTOMATIZADO / ENTREPÔT AUTOMATISÉ / AUTOMATED STORAGE

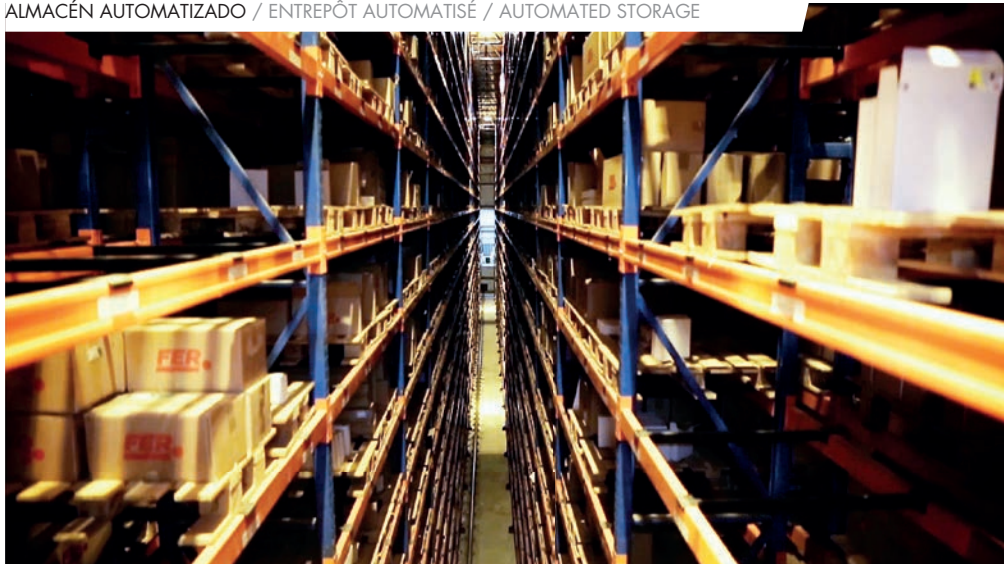

EN

**FER** is a company established in 1969 which, nowadays, has a staff consisting of more than 70 people.

We develop products together with various partners, anticipating the market needs and importing them, packing them in our specialised industrial plants and distributing them to our sales outlets and traditional warehouses, wholesalers of hardware, carpentry and electricity, DIY superstores and food supermarkets.

This catalogue features our three main lines of business: screws, hardware and keyhole machines.

We provide our clients with high standards of versatility and adaptability, which allow the product to be delivered in different types of packaging (plastic and cardboard boxes, skin pack, high frequency blister packs, bags, etc.) in short periods of time.

- ✓ **More than 9000 references.**
- ✓ **Customised packaging service in own facilities.**
- ✓ **Intelligent automated storage of 21,000 locations with the possibility of picking in the cart, which substantially reduces the packaging and issuing times.**
- ✓ **Delivery in 48 - 72 hours.**

LINEAL DE AUTOSERVICIO / LINÉAIRE DE LIBRE-SERVICE / SELF-SERVICE



ÍNDICE  
SOMMAIRE / INDEX

7  
TORNILLERÍA  
TRÉFILERIE / FASTENERS

<b>EXPOSITORES</b>	
PRÉSENTOIRS / DISPLAYS .....	8
<b>FER EASY</b> .....	12
<b>SUJECIONES</b>	
PIONNERIE / SCREW EYE & HOOKS.....	14
<b>PUNTAS</b>	
CLOUTERIE / NAILS .....	20
<b>TORNILLERÍA MADERA</b>	
VISSERIE / WOOD SCREWS.....	30
<b>TORNILLERÍA METAL</b>	
BOULONNERIE / BOLTS .....	37
<b>FUJACIONES</b>	
CHEVILLES / PLUGS.....	46
<b>ACCESORIOS MADERA</b>	
ARTICLES POUR LE BOIS / WOOD ACCESORIES .....	56
<b>INOX</b>	
INOX / STAINLESS STEEL .....	62
<b>ESTUCHES SURTIDOS</b>	
BOÎTES ASSORTIES / ASSORTED BOXES .....	67
<b>VARILLAS ROSCADAS</b>	
TIGE FILETÉE / THREADED RODS .....	68

**69**  
**QUINCALLERÍA**  
QUINCALLERIE / HARDWARE

**ACCESORIOS DE CERRAJERÍA Y SEGURIDAD | ESCUADRAS**

ACCESOIRES DE SERRURERIE ET SECURITE / EQUERRES  
LOOKSMITH AND SECURITY ACCESSORIES / SQUARES ..... 70

**ACCESORIOS PERSIANAS**

ACCESOIRES VOLETS ROULANTS - BLINDS ACCESSORIES ..... 73

**PERFILES | REJILLAS DE VENTILACIÓN | RUEDAS**

BARRES DE SEUIL / GRILLES DE VENTILATION / ROULETTES  
PROFILES / VENTILATION GRATES / WHEELS ..... 74

**TOPES DE PUERTA**

BUTEES DE PORTE / DOOR STOPS ..... 75

**FIELTROS | ANTIDESLIZANTES | PATINES | CONTERAS**

PATINS ANTIDERAPANTS, AMORTISSEURS, GLISSEURS ET PATINS ENVELOPPANTS  
FELTS, ANTI-SLIPS, PADS AND FURNITURE FEET PROTECTORS ..... 77

**CORDELERÍA | ALAMBRES**

CORDAGES / FILES DE FER - ROPES / WIRES ..... 78

**CANDADOS**

CADENAS / PADLOCKS ..... 80

**BRIDAS**

COLLIERS / CABLE TIES ..... 80

**PALOMILLAS**

CONSOLES / BRACKETS ..... 80

**81**  
**MÁQUINAS BOCALLAVES**  
MACHINES TROU DE CLEF / MACHINES KEYWAY

**MÁQUINAS**

MACHINES / MACHINES ..... 82

**UTILLAJES**

OUTILLAGES / DEVICES ..... 83

**CONDICIONES GENERALES DE VENTA ..... 84**

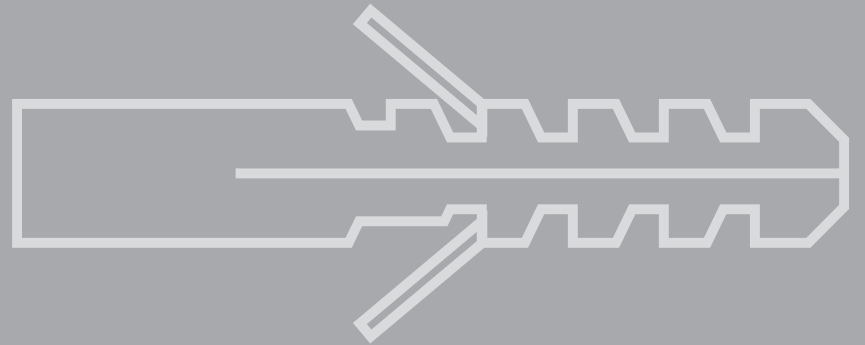
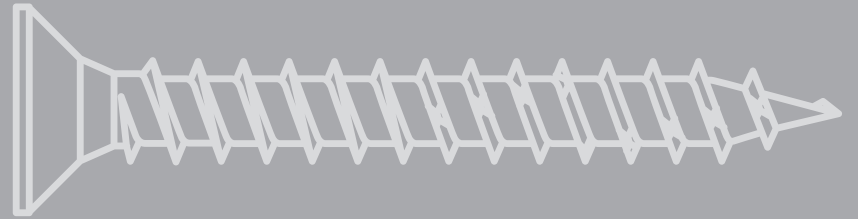

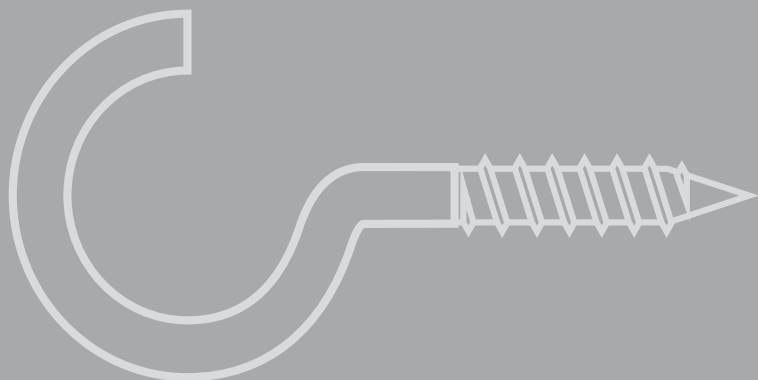

TORNILLERÍA  
TRÉFILERIE / FASTENERS

## EXPOSITOR DE PIE

**86** REFERENCIAS

### MEDIDAS

ALTO	2.400 mm
ANCHO	630 mm
FONDO	370 mm

### UNIDADES DE EMBALAJE

Bolsas 10 unidades en todas las referencias.

**COMPOSICIÓN:** 20 unidades en bolsas simples y 10 unidades en bolsas dobles.

### PRECIO

Precio tarifa composición (material)	1.302,60 € *
--------------------------------------	--------------

\* Precio para propuesta de implantación estándar de FER; en caso de implantación personalizada, los precios podrían sufrir variaciones.



## EXPOSITOR DE SOBREMESA O PARED

**36** REFERENCIAS

### MEDIDAS

ALTO	820 mm
ANCHO	420 mm
FONDO	330 mm

### UNIDADES DE EMBALAJE

Caja de colgar 12 unidades en todas las referencias.

**COMPOSICIÓN:** 12 unidades de todas las referencias.

### PRECIO

Precio tarifa composición (material)	388,80 € *
--------------------------------------	------------

\* Precio para propuesta de implantación estándar de FER; en caso de implantación personalizada, los precios podrían sufrir variaciones.





## EXPOSITOR DE PIE

**140** REFERENCIAS

### MEDIDAS

ALTO	2.200 mm
ANCHO	705 mm
FONDO	490 mm

### UNIDADES DE EMBALAJE

Caja de colgar 12 unidades en todas las referencias.

### PRECIO

Precio tarifa composición (material)	1.512,00 € *
--------------------------------------	--------------

\* Precio para propuesta de implantación estándar de FER; en caso de implantación personalizada, los precios podrían sufrir variaciones.



## EXPOSITOR DE PIE FAMILIA INOXIDABLE

**140** REFERENCIAS

### MEDIDAS

ALTO	2.200 mm
ANCHO	705 mm
FONDO	490 mm

### UNIDADES DE EMBALAJE

Caja de colgar 12 unidades en todas las referencias.

### PRECIO

Precio tarifa composición (material)	2.291,52 € *
--------------------------------------	--------------

\* Precio para propuesta de implantación de familia inoxidable de FER; en caso de implantación personalizada, los precios podrían sufrir variaciones.

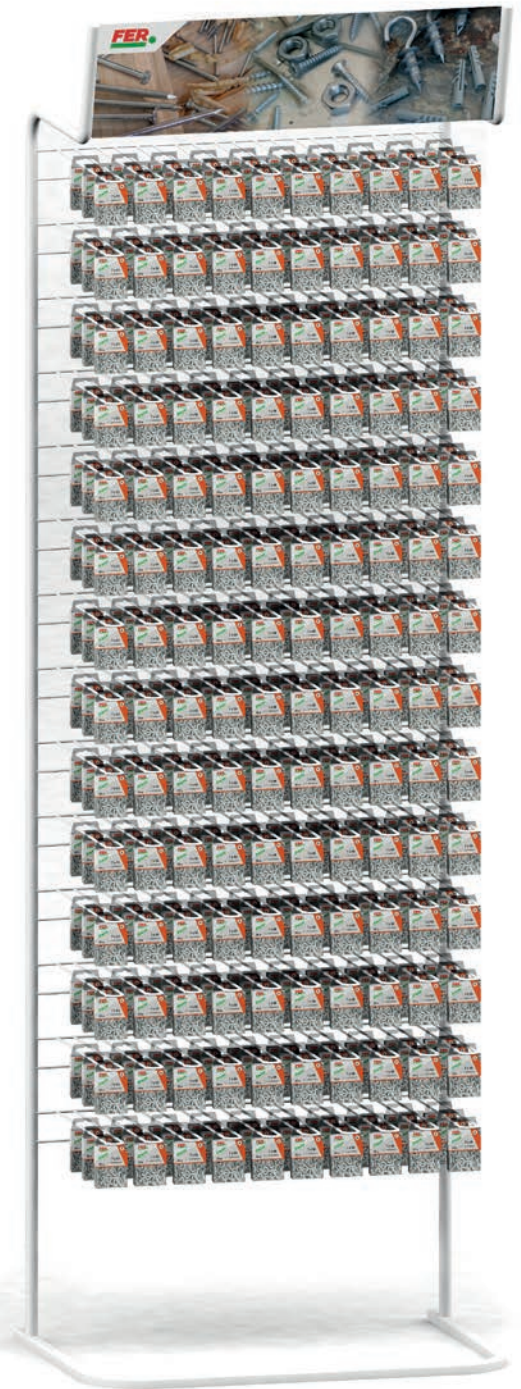

## EXPOSITOR DE 1,30 m BOLSA

**172** REFERENCIAS

### MEDIDAS

ALTO	2.400 mm
ANCHO	1.250 mm
FONDO	510 mm

### UNIDADES DE EMBALAJE

Bolsas 10 unidades en todas las referencias.  
Cajas pequeñas, medianas y grandes 12,10  
y 8 unidades en todas las referencias.

**COMPOSICIÓN:** 20 unidades en bolsas.  
Cajas pequeñas, medianas y grandes 12,10  
y 8 unidades de todas las referencias.

### PRECIO

Precio tarifa composición (material)	3.008,03 € *
---	--------------

\* Precio para propuesta de implantación estándar  
de FER; en caso de implantación personalizada, los  
precios podrían sufrir variaciones.



## EXPOSITOR DE 1,30 m

**248** REFERENCIAS

### MEDIDAS

ALTO	2.200 mm
ANCHO	1.250 mm
FONDO	510 mm

### UNIDADES DE EMBALAJE

Caja de colgar 12 o 10 unidades en todas las referencias. Cajas pequeñas, medianas y grandes 12, 10 y 8 unidades en todas las referencias.

### PRECIO

Precio tarifa composición (material)	3.293,23 € *
--------------------------------------	--------------

\* Precio para propuesta de implantación estándar de FER; en caso de implantación personalizada, los precios podrían sufrir variaciones.

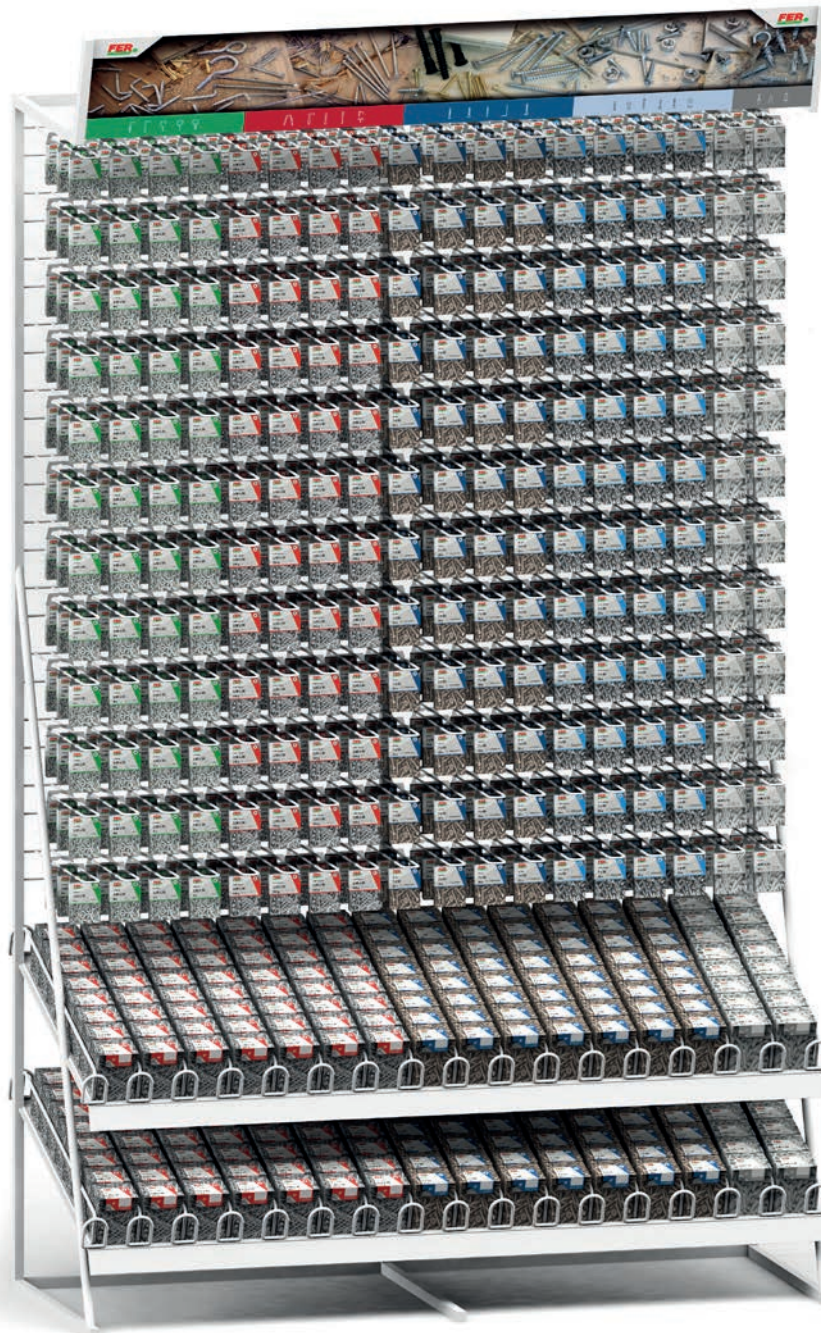

## PRESENTAMOS EL NUEVO CONCEPTO DE AUTOSERVICIO

# FEReasy

## VENTAJAS

- ✓ Autoservicio que **VENDE SOLO.**
- ✓ **TRES EN UNO**  
Posibilidad de gama doméstica, semi-profesional y profesional en un mismo espacio.
- ✓ **VERSÁTIL Y FLEXIBLE**  
Diferentes planteamientos para diferentes necesidades: propuesta de implantación personalizada a las necesidades del cliente y al espacio disponible.
- ✓ **DIDÁCTICA**  
PLV pensada para educar al consumidor y facilitar la selección del producto más adecuado. Posibilidad de descarga a dispositivos móviles por código QR.
- ✓ **ASESORAMIENTO**  
Medición, adecuación de gama, implantación.
- ✓ **VENTAJAS COMERCIALES**  
Añadidas por nueva implantación o reestructuración de implantaciones.



MÁS INFORMACIÓN EN:

ventas@industriasfer.com

o en el **943 752 000**



FER  
ACERO INOXIDABLE  
7 x 50  
25 u

**CÓDIGO PRECIO**

CÓDIGO PRECIO	P.V.P.
A	1,00 €
B	1,25 €
C	1,45 €
D	1,70 €
E	1,95 €
F	2,45 €

CÓDIGO PRECIO	P.V.P.
G	2,95 €
H	3,50 €
I	4,50 €
J	5,90 €
K	7,50 €
L	8,90 €

**DESCÁRGATELO EN PDF**

**RESISTENCIA A LA OXIDACIÓN**

		MATERIAL	
		ACERO INOX	ACERO
ACABADO	INIX	★★★★	
	ZINCADO		★★★
	LATORADO		★★

**NIVEL DE SUJECIÓN**

		LONGITUD mm			
		+30	30-60	60-80	+ 80
Ø DIÁMETRO	M2	*	*	*	*
	M3	*	*	*	*
	M4	*	*	*	*
	M5	*	*	*	*
	M6	*	*	*	*
	M8	*	*	*	*

**TIRAFONDOS ROSCA CHAPA**

**TORNILLOS AUTOPERFORANTES**

**CABEZA OVAL**

**CABEZA REDONDA**

**TIPOS DE ARANDELAS Y APLICACIONES**

Ø DIÁMETRO DEL TIRAFONDO mm	Ø DIÁMETRO DEL PERFORADO mm
2,90	2,50
3,50	2,80
3,90	3
4,20	3,50
4,80	4
5,50	4,70

**FUNCIONES DE LAS ARANDELAS**

1. Proteger las superficies de contacto contra las espigas e emisiones que pueden producir los tornillos o tuercas por rozamiento.
2. Repartir de forma homogénea la fuerza de apriete para obtener uniones fuertes y resistentes a la presión mecánica.
3. Distribuir la fuerza de apriete a zonas alejadas de las zonas de sujeción del tornillo o tuerca, en algunos casos (distribuidores, roscados, etc.).
4. Reducir las riesgos de abollamiento al apriete cuando el coeficiente de fricción sobre el tornillo o tuerca (concretamente distribuidores).
5. Asegurar una posible pérdida de tensión de apriete por deformación de las piezas (tornillos Conner elastostatic).
6. Compensar las fallas de paralelismo de las piezas o de superficies irregulares.

MÁS INFORMACIÓN EN:  
ventas@industriasfer.com  
o en el 943 752 000



MEDIDA: DIMENSION / SIZE | Nº PIEZAS: Nº PCS / Nº PCS | UDS. EMBALAJE: U.C. / PACKING | PRECIO TARIFA: PRIX / PRICE

MEDIDA	BOLSA SACHET BAG				PEQUEÑOS TRABAJOS BRICOLAGE D.I.Y.				CAJA PROFESIONAL PLÁSTICO BOÎTE PROFESSIONNELLE PROFESSIONAL BOX				CAJA PROFESIONAL CARTÓN BOÎTE PROFESSIONNELLE CARTON PROFESSIONAL CARTON BOX					
	REF.	Nº PIEZAS	UDS. EMBALAJE	PRECIO TARIFA	REF.	Nº PIEZAS	UDS. EMBALAJE	PRECIO TARIFA	REF.	Nº PIEZAS	UDS. EMBALAJE	UDS. PEDIDO	PRECIO TARIFA	REF.	Nº PIEZAS	UDS. EMBALAJE	PRECIO TARIFA	
<b>ALCAYATA DE ACERO</b> ZINCADO GOND À POINTE ACIER TREMPÉ ZINGUÉ SQUARE HOOKPIN HARDENED ZINC PLATED	2,25x20	4812	30	10	0,730	2001	40	12	0,900	43603	250	48	12	3,279	5001	300	54	3,856
	2,25x30	4813	25	10	0,730	2002	25	12	0,900	43604	175	48	12	3,279	5002	300	54	4,914
	2,90x40	4814	12	10	0,730	2003	14	12	0,900	43605	75	48	12	3,279	5003	300	27	9,886
	2,90x50	4815	7	10	0,730	2004	7	12	0,900						5004	300	18	12,393
	2,90x60					2005	5	12	0,900						5005	300	9	16,079
<b>ALCAYATA DE HIERRO</b> ZINCADO GOND À POINTE ACIER ZINGUÉ SQUARE HOOKPIN ZINC PLATED	16x30					20073	25	12	0,900					50073	300	54	3,303	
	16x35													50074	300	54	3,726	
	17x40					20075	15	12	0,900					50075	300	54	4,786	
	18x50					20076	8	12	0,900					50076	300	27	8,107	
	18x60													50093	200	27	5,872	
	19x60					20077	5	12	0,900					50077	200	27	8,319	
	19x70													50078	200	18	10,118	
	20x70					20082	6	12	0,900					50082	200	18	12,052	
	20x80													50083	100	27	7,225	
	20x90													50084	100	18	8,602	
	21x80													50085	100	27	8,255	
	21x90													50086	100	18	9,587	
	21x100													50087	100	18	10,748	
	22x100													50088	100	9	12,555	
	22x110													50089	100	9	14,099	
	22x120													5009	100	9	15,370	
	23x130													50097	100	9	21,434	
<b>ESCARPIA ROSCADA</b> ZINCADO GOND À VIS ACIER ZINGUÉ SQUARE SCREW HOOK ZINC PLATED	14x25	4816	25	10	0,730	2010	25	12	0,900	43606	200	160	10	3,279	5010	500	54	7,189
	14x30					20102	25	12	0,900					50102	500	54	7,365	
	16x30	4817	25	10	0,730	2011	25	12	0,900	43607	175	160	10	3,279	5011	300	54	4,977
	16x35	41480	20	10	0,730	20113	25	12	0,900					50113	300	54	5,355	
	17x35	41481	20	10	0,730	20117	25	12	0,900					50117	300	54	6,395	
	17x40	4818	20	10	0,730	2012	20	12	0,900	43608	100	48	12	3,279	5012	300	27	7,295
	17x50	4819	15	10	0,730	20123	15	12	0,900					50123	300	27	7,624	
	18x40	4820	15	10	0,730	20125	15	12	0,900					50125	300	27	7,913	
	18x45					20127	15	12	0,900					50127	300	27	8,143	
	18x50	4821	10	10	0,730	2013	10	12	0,900	43609	100	48	12	3,279	5013	300	27	8,893
	18x60	41482	10	10	0,730	20133	10	12	0,900					50133	200	27	6,580	
	19x50	4822	10	10	0,730	20135	10	12	0,900					50135	200	27	7,498	
	19x60	4823	7	10	0,730	2014	7	12	0,900	43610	75	24	8	3,279	5014	200	18	8,806
	19x65													50141	200	18	9,654	
	19x70					20143	7	12	0,900					50143	200	18	10,176	
	20x50					20147	8	12	0,900					50147	200	27	8,884	
	20x60	41483	6	10	0,730	20148	6	12	0,900					50148	200	18	10,840	



MEDIDA: DIMENSION / SIZE | Nº PIEZAS: Nº PCS / Nº PCS | UDS. EMBALAJE: U.C. / PACKING | PRECIO TARIFA: PRIX / PRICE



**BOLSA**  
SACHET  
BAG



**PEQUEÑOS TRABAJOS**  
BRICOLAGE  
D.I.Y.



**CAJA PROFESIONAL PLÁSTICO**  
BOÎTE PROFESSIONNELLE  
PROFESSIONAL BOX



**CAJA PROFESIONAL CARTÓN**  
BOÎTE PROFESSIONNELLE CARTON  
PROFESSIONAL CARTON BOX

MEDIDA	BOLSA SACHET BAG				PEQUEÑOS TRABAJOS BRICOLAGE D.I.Y.				CAJA PROFESIONAL PLÁSTICO BOÎTE PROFESSIONNELLE PROFESSIONAL BOX					CAJA PROFESIONAL CARTÓN BOÎTE PROFESSIONNELLE CARTON PROFESSIONAL CARTON BOX			
	REF.	Nº PIEZAS	UDS. EMBALAJE	PRECIO TARIFA	REF.	Nº PIEZAS	UDS. EMBALAJE	PRECIO TARIFA	REF.	Nº PIEZAS	UDS. EMBALAJE	UDS. PEDIDO	PRECIO TARIFA	REF.	Nº PIEZAS	UDS. EMBALAJE	PRECIO TARIFA
20x70	4824	6	10	0,730	2015	6	12	0,900	43611	50	24	8	3,279	5015	200	9	12,674
20x80					20152	4	12	0,900						50152	100	18	7,510
20x90					20154	5	10	0,900						50154	100	9	8,574
21x60					20157	4	12	0,900						50157	100	27	7,048
21x70					20159	4	12	0,900						50159	100	27	7,451
21x80	41633	4	10	0,730	2016	4	12	0,900						5016	100	18	8,222
21x90	41634	3	10	0,730										50162	100	9	9,368
21x100					20164	4	10A	1,778						50164	100	9	10,318
22x70					20166	4	12	0,900						50166	100	27	8,441
22x80					20168	4	12	0,900						50168	100	9	10,174
22x90					2017	3	10A	1,778						5017	100	9	11,258
22x100														50173	100	9	12,115
22x110														5018	100	9	13,064
22x120														50183	75	9	10,330
23x100														50192	100	9	18,635
23x130														50196	50	9	10,122

Continuación de página anterior

**ESCARPIA ROSCADA**

ZINCADO  
GOND À VIS ACIER ZINGUÉ  
SQUARE SCREW HOOK ZINC PLATED



**ESCARPIA ROSCADA**

LATONADO  
GOND À VIS ACIER LAITONNÉ  
SQUARE SCREW HOOK BRASS PLATED



**ESCARPIA ROSCADA**

PINTADO  
GOND À VIS BLANC  
SQUARE SCREW HOOK WHITE



**HEMBRILLA ABIERTA**

ZINCADO  
CROCHET OUVERT ACIER ZINGUÉ  
CUP HOOK ZINC PLATED





14x25					2021	22	12	0,900									
16x30	4825	20	10	0,730	2022	20	12	0,900						5022	300	54	7,518
17x40	4826	14	10	0,730	2023	15	12	0,900						5023	300	27	12,315
18x50	4827	10	10	0,730	2024	10	12	0,900						5024	300	27	15,264
19x60	4828	7	10	0,730	2025	7	12	0,900						5025	200	18	15,437
20x70					2026	6	12	0,900						5026	200	9	21,509

14x25					2030	20	12	0,900									
16x30	4829	15	10	0,730	2031	16	12	0,900						5031	300	54	9,425
17x40	4830	8	10	0,730	2032	10	12	0,900						5032	300	27	16,002
18x50	4831	6	10	0,730	2033	8	12	0,900						5033	300	27	21,042
19x60	41484	4	10	0,730	2034	5	12	0,900						5034	200	18	20,480
20x70					2035	4	12	0,900						5035	200	9	28,551

14x25	4832	25	10	0,730	2040	25	12	0,900	43612	175	160	10	3,279	5040	500	54	7,189
16x30	4833	20	10	0,730	2041	25	12	0,900	43613	150	48	12	3,279	5041	300	54	5,327
16x35					20413	25	12	0,900						50413	300	54	5,418
17x35					20417	17	12	0,900						50417	300	27	7,349
17x40	4834	15	10	0,730	2042	15	12	0,900	43614	100	48	12	3,279	5042	300	27	8,201
17x50														50423	300	18	9,421
18x50	4835	8	10	0,730	2043	8	12	0,900	43615	80	24	8	3,279	5043	300	18	10,315
18x60					20433	8	12	0,900						50433	200	27	7,392
19x60	4836	5	10	0,730	2044	5	12	0,900	43616	65	24	8	3,279	5044	200	18	9,595



MEDIDA: DIMENSION / SIZE | Nº PIEZAS: Nº PCS / Nº PCS | UDS. EMBALAJE: U.C. / PACKING | PRECIO TARIFA: PRIX / PRICE

MEDIDA	BOLSA SACHET BAG				PEQUEÑOS TRABAJOS BRICOLAGE D.I.Y.				CAJA PROFESIONAL PLÁSTICO BOÎTE PROFESSIONNELLE PROFESSIONAL BOX					CAJA PROFESIONAL CARTÓN BOÎTE PROFESSIONNELLE CARTON PROFESSIONAL CARTON BOX			
	REF.	Nº PIEZAS	UDS. EMBALAJE	PRECIO TARIFA	REF.	Nº PIEZAS	UDS. EMBALAJE	PRECIO TARIFA	REF.	Nº PIEZAS	UDS. EMBALAJE	UDS. PEDIDO	PRECIO TARIFA	REF.	Nº PIEZAS	UDS. EMBALAJE	PRECIO TARIFA
<b>HEMRILLA ABIERTA</b> ZINCADO CROCHET OUVERT ACIER ZINGUÉ CUP HOOK ZINC PLATED																	
																	
19x70					20443	5	12	0,900						50443	200	9	11,706
19x80														50445	200	9	12,447
20x60														50448	200	9	13,640
20x70	41635	4	10	0,730	2045	5	12	0,900	43617	50	24	8	3,279	5045	200	9	14,387
20x80					20451	4	12	0,900						50451	100	18	7,938
20x90					20452	4	12	0,900						50452	100	9	8,350
21x70					2046	3	12	0,900						5046	100	18	9,190
21x80					20462	3	12	0,900						50462	100	9	10,431
21x90					20464	3	12	0,900						50464	100	9	10,854
21x100	41636	3	10	0,730	20466	3	12	0,900						50466	100	9	11,398
22x80					2047	3	12	0,900						5047	100	9	12,482
22x90														50472	100	9	13,414
22x100														50474	100	9	14,434
22x110														50476	75	9	11,508
22x120														50478	75	9	12,004
23x90														5049	100	9	19,594
23x130														50496	40	9	8,385
23x150														5050	40	9	9,066
<b>HEMRILLA ABIERTA</b> LATONADO CROCHET OUVERT ACIER LATONNÉ CUP HOOK BRASS PLATED																	
																	
14x25					2051	20	12	0,900						5051	500	54	9,958
16x30					2052	20	12	0,900						5052	300	54	8,288
17x40					2053	10	12	0,900						5053	300	27	12,321
18x50					2054	8	12	0,900						5054	300	18	16,488
19x60					2055	5	12	0,900						5055	200	18	16,264
20x70					2056	5	12	0,900						5056	200	9	24,030
<b>HEMRILLA ABIERTA</b> PINTADO CROCHET OUVERT BLANC / CUP HOOK WHITE																	
																	
14x25					2060	16	12	0,900						5060	500	54	12,337
16x30					2061	12	12	0,900						5061	300	54	10,273
17x40					2062	8	12	0,900						5062	300	27	17,589
18x50					2063	6	12	0,900						5063	300	18	23,297
19x60					2064	4	12	0,900						5064	200	18	23,994
20x70					2065	3	12	0,900						5065	200	9	35,236





MEDIDA: DIMENSION / SIZE | Nº PIEZAS: Nº PCS / Nº PCS | UDS. EMBALAJE: U.C. / PACKING | PRECIO TARIFA: PRIX / PRICE

MEDIDA	BOLSA SACHET BAG				PEQUEÑOS TRABAJOS BRICOLAGE D.I.Y.				CAJA PROFESIONAL PLÁSTICO BOÎTE PROFESSIONNELLE PROFESSIONAL BOX				CAJA PROFESIONAL CARTÓN BOÎTE PROFESSIONNELLE CARTON PROFESSIONAL CARTON BOX			
	REF.	Nº PIEZAS	UDS. EMBALAJE	PRECIO TARIFA	REF.	Nº PIEZAS	UDS. EMBALAJE	PRECIO TARIFA	REF.	Nº PIEZAS	UDS. EMBALAJE	UDS. PEDIDO	PRECIO TARIFA	REF.	Nº PIEZAS	UDS. EMBALAJE

**HEMBRILLA CERRADA**

ZINCADO  
PITON FERMÉ ACIER ZINGUÉ  
SCREW EYE ZINC PLATED



14x25	4837	25	10	0,730	2070	25	12	0,900	43618	175	160	10	3,279	5070	500	54	7,189
14x30					20703	24	12	0,900						50703	500	54	7,365
16x30	4838	20	10	0,730	2071	24	12	0,900	43619	150	48	12	3,279	5071	300	54	5,269
16x35					20713	20	12	0,900						50713	300	54	5,370
17x35					20717	18	12	0,900						50717	300	27	7,162
17x40	4839	15	10	0,730	2072	18	12	0,900	43620	90	48	12	3,279	5072	300	27	8,028
17x50														50723	300	27	8,893
17x60														50724	300	27	9,169
18x40					20725	12	12	0,900						50725	300	27	9,168
18x50	4840	10	10	0,730	2073	10	12	0,900	43621	80	24	8	3,279	5073	300	18	10,128
18x60					20733	9	12	0,900						50733	200	27	7,209
19x50					20735	7	12	0,900						50735	200	18	9,357
19x60	4841	6	10	0,730	2074	6	12	0,900	43622	65	24	8	3,279	5074	200	18	9,595
19x70					20742	6	12	0,900						50742	200	18	10,630
20x60					20748	5	12	0,900						50748	200	9	12,356
20x70	4842	4	10	0,730	2075	4	12	0,900	43623	50	24	8	3,279	5075	200	9	13,656
20x80					20752	4	12	0,900						50752	100	18	7,650
20x90					20754	3	12	0,900						50754	100	18	8,015
21x60					2076	4	12	0,900						5076	100	27	8,186
21x70														50762	100	18	9,033
21x80	41637	4	10	0,730	20764	4	12	0,900						50764	100	18	9,512
21x90					20766	3	12	0,900						50766	100	18	9,962
21x100					20768	3	12	0,900						50768	100	9	10,691
22x80														50772	100	18	11,386
22x100					20776	3	12	0,900						50776	100	9	12,664
22x120					2078	2	10A	1,778						5078	100	9	13,804
23x90														5079	100	9	19,338
23x110														50794	75	9	15,735
23x130														50796	75	9	17,339

**HEMBRILLA CERRADA**





LATONADO  
PITON FERMÉ ACIER LAITONNÉ  
SCREW EYE BRASS PLATED



14x25	4843	20	10	0,730	2081	21	12	0,900						5081	500	54	9,958
16x30	4844	16	10	0,730	2082	20	12	0,900						5082	300	54	7,580
17x40	4845	10	10	0,730	2083	14	12	0,900						5083	300	27	11,934
18x50	4846	8	10	0,730	2084	10	12	0,900						5084	300	18	16,573
19x60	4847	6	10	0,730	2085	6	12	0,900						5085	200	18	15,791
20x70					2086	4	12	0,900						5086	200	9	23,334







MEDIDA: DIMENSION / SIZE | Nº PIEZAS: Nº PCS / Nº PCS | UDS. EMBALAJE: U.C. / PACKING | PRECIO TARIFA: PRIX / PRICE

MEDIDA	BOLSA SACHET BAG				PEQUEÑOS TRABAJOS BRICOLAGE D.I.Y.				CAJA PROFESIONAL PLÁSTICO BOÎTE PROFESSIONNELLE PROFESSIONAL BOX				CAJA PROFESIONAL CARTÓN BOÎTE PROFESSIONNELLE CARTON PROFESSIONAL CARTON BOX				
	REF.	Nº PIEZAS	UDS. EMBALAJE	PRECIO TARIFA	REF.	Nº PIEZAS	UDS. EMBALAJE	PRECIO TARIFA	REF.	Nº PIEZAS	UDS. EMBALAJE	UDS. PEDIDO	PRECIO TARIFA	REF.	Nº PIEZAS	UDS. EMBALAJE	PRECIO TARIFA
<b>HEMRILLA CERRADA</b> PINTADO PITON FERMÉ BLANC / SCREW EYE WHITE 	14x25	4848	15	10	0,730	2090	20	12	0,900					5090	500	54	12,337
	16x30	4849	12	10	0,730	2091	12	12	0,900					5091	300	54	10,294
	17x40	4850	6	10	0,730	2092	8	12	0,900					5092	300	27	17,237
	18x50					2093	6	12	0,900					5093	300	18	24,203
	19x60					2094	4	12	0,900					5094	200	18	24,295
	20x70					2095	3	12	0,900					5095	200	9	34,150
<b>HEMRILLA CERRADA OVALADA</b> LATONADO PITON OVALE ACIER LAITONNÉ OVAL SCREW EYE BRASS PLATED 	2x8													50800	200	54	3,808
	2,7x10													50801	200	54	5,948
	3x12													50802	200	27	8,547
<b>ESCARPIA DECORATIVA</b> GOND D'EMBRASSE / CURTAIN SQUARE HOOK 	35 mm					21208	2	12	3,333								
<b>GANCHO DE COCINA</b> LATONADO CROCHET D'EMBRASSE ACIER LAITONNÉ KITCHEN HOOK BRASS PLATED 	22 mm	41600	2	10	0,730	2121	5	12	1,353								
	31 mm					21212	2	10	1,778								
<b>GANCHO DE COCINA</b> ORO VIEJO CROCHET D'EMBRASSE BRONCE KITCHEN HOOK ANTIQUE BRASS 	31 mm					21213	2	10	1,778								



MEDIDA: DIMENSION / SIZE | Nº PIEZAS: Nº PCS / Nº PCS | UDS. EMBALAJE: U.C. / PACKING | PRECIO TARIFA: PRIX / PRICE

MEDIDA	BOLSA SACHET BAG				PEQUEÑOS TRABAJOS BRICOLAGE D.I.Y.				CAJA PROFESIONAL PLÁSTICO BOÎTE PROFESSIONNELLE PROFESSIONAL BOX				CAJA PROFESIONAL CARTÓN BOÎTE PROFESSIONNELLE CARTON PROFESSIONAL CARTON BOX				
	REF.	Nº PIEZAS	UDS. EMBALAJE	PRECIO TARIFA	REF.	Nº PIEZAS	UDS. EMBALAJE	PRECIO TARIFA	REF.	Nº PIEZAS	UDS. EMBALAJE	UDS. PEDIDO	PRECIO TARIFA	REF.	Nº PIEZAS	UDS. EMBALAJE	PRECIO TARIFA
<b>COLGADOR CON ESPÁRAGO</b> BRONCEADO CROCHET DÉCORATIF BRONCE SWAG HOOK ANTIQUE BRASS 					21218	1	10	1,778									
<b>COLGADOR CON ESPÁRAGO</b> LATONADO CROCHET DÉCORATIF ACIER LAITONNÉ SWAG HOOK BRASS PLATED 					21219	1	10	1,778									
<b>ANILLA</b> ZINCADO ANNEAU ACIER ZINGUÉ RING ZINC PLATED 	20 mm				2134	8	12	0,900									
	25 mm				2135	6	12	0,900									
<b>GANCHO CERRADO ROSCA MÉTRICA CON TUERCA</b> ZINCADO PITON FERMÉ MÉTAUX AVEC ECROU ACIER ZINGUÉ EYE BOLT WITH NUT ZINC PLATED 	M3x26 mm												5150	100	27	25,789	
	M12x75 mm				21505	1	10A	2,533						51505	20	9	44,254
<b>GANCHO ABIERTO ROSCA MÉTRICA CON TUERCA</b> ZINCADO CROCHET MÉTAUX AVEC ECROU ACIER ZINGUÉ CUP HOOK WITH NUT ZINC PLATED 	M3x26 mm												51506	100	27	23,293	
	M4x35 mm													51507	100	27	25,789
	M5x37 mm				21508	2	12	0,900						51508	100	18	30,918
	M8x60 mm													51510	50	9	33,761







MEDIDA: DIMENSION / SIZE | Nº PIEZAS: Nº PCS / Nº PCS | UDS. EMBALAJE: U.C. / PACKING | PRECIO TARIFA: PRIX / PRICE

MEDIDA	BOLSA SACHET BAG				PEQUEÑOS TRABAJOS BRICOLAGE D.I.Y.				CAJA PROFESIONAL PLÁSTICO BOÎTE PROFESSIONNELLE PROFESSIONAL BOX					CAJA PROFESIONAL CARTÓN BOÎTE PROFESSIONNELLE CARTON PROFESSIONAL CARTON BOX				
	REF.	Nº PIEZAS	UDS. EMBALAJE	PRECIO TARIFA	REF.	Nº PIEZAS	UDS. EMBALAJE	PRECIO TARIFA	REF.	Nº PIEZAS	UDS. EMBALAJE	UDS. PEDIDO	PRECIO TARIFA	REF.	Nº PIEZAS	UDS. EMBALAJE	PRECIO TARIFA	
<b>PUNTA DE ACERO</b>	1,15x20	4851	125	10	0,730	2209	125	12	0,900					5209	1000	54	3,836	
<b>CABEZA PLANA</b>	1,50x15	4852	125	10	0,730	2210	125	12	0,900	43320	900	48	12	3,279	5210	1000	54	4,272
<b>ZINCADO</b>	1,50x20	4853	100	10	0,730	2211	100	12	0,900	43321	700	48	12	3,279	5211	1000	54	5,444
POINTE TÊTE PLATE ACIER TREMPÉ ZINGUÉ FLAT HEAD HARDENED STEEL NAIL ZINC PLATED	1,50x25	4854	80	10	0,730	2212	80	12	0,900	43322	650	24	8	3,279	5212	1000	54	6,536
	2x18					22122	70	12	0,900					52122	500	54	2,454	
	2x20													52123	500	54	2,606	
	2x25					22124	35	12	0,900					52124	500	54	2,932	
	2x30					22126	35	12	0,900					52126	500	54	3,750	
	2,25x20	4855	60	10	0,730	2213	60	12	0,900	43323	500	48	12	3,279	5213	500	54	3,110
	2,25x25					22133	35	12	0,900	43324	350	24	8	3,279	52133	500	54	3,786
	2,25x30	4856	30	10	0,730	2214	30	12	0,900	43325	300	24	8	3,279	5214	500	27	4,315
	2,50x30					22143	28	12	0,900	43326	225	48	12	3,279	52143	500	27	4,915
	2,50x35					22145	22	12	0,900					52145	500	27	5,153	
	2,50x40	4857	20	10	0,730	2215	20	12	0,900	43327	170	24	8	3,279	5215	500	27	6,381
	2,50x50	4858	15	10	0,730	2216	15	12	0,900	43328	140	24	8	3,279	5216	300	27	4,874
	2,70x20													52163	500	27	4,393	
	2,70x30													52165	500	27	5,837	
	2,70x40													52167	500	27	7,325	
	2,70x50													52166	300	27	5,605	
	2,70x60					2217	13	12	0,900	43329	125	24	8	3,279	5217	300	18	6,819
	2,90x40													5218	300	27	5,675	
	2,90x50													52181	300	27	6,283	
	2,90x60					22182	13	12	0,900					52182	300	18	7,712	
	2,90x70					22184	13	12	0,900					52184	300	9	8,499	
	2,90x80													52185	200	9	6,921	
	3,40x30													52186	200	54	3,180	
	3,40x40					22188	13	12	0,900					52188	200	27	4,712	
	3,40x40													52190	100	54	2,645	
	3,40x50					2219	12	12	0,900					5219	200	27	5,715	
	3,40x50									43330	80	24	8	3,279	52191	100	54	3,146
	3,40x60					22192	9	12	0,900	43331	60	48	12	3,279	52192	100	27	3,779
	3,40x70					22194	9	12	0,900					52194	100	27	4,020	
	3,40x80													52196	100	27	4,442	
<b>ALFILER DE ACERO</b>																		
<b>ZINCADO</b>																		
POINTE À PLACAGE ACIER TREMPÉ ZINGUÉ HARDENED PIN ZINC PLATED	0,9x30					2223	100	12	0,900									



MEDIDA: DIMENSION / SIZE | Nº PIEZAS: Nº PCS / Nº PCS | UDS. EMBALAJE: U.C. / PACKING | PRECIO TARIFA: PRIX / PRICE

MEDIDA	BOLSA SACHET BAG				PEQUEÑOS TRABAJOS BRICOLAGE D.I.Y.				CAJA PROFESIONAL PLÁSTICO BOÎTE PROFESSIONNELLE PROFESSIONAL BOX					CAJA PROFESIONAL CARTÓN BOÎTE PROFESSIONNELLE CARTON PROFESSIONAL CARTON BOX			
	REF.	Nº PIEZAS	UDS. EMBALAJE	PRECIO TARIFA	REF.	Nº PIEZAS	UDS. EMBALAJE	PRECIO TARIFA	REF.	Nº PIEZAS	UDS. EMBALAJE	UDS. PEDIDO	PRECIO TARIFA	REF.	Nº PIEZAS	UDS. EMBALAJE	PRECIO TARIFA
<b>PUNTA DE ACERO</b> <b>CABEZA CÓNICA</b> ZINCADO POINTE TÊTE HOMME ACIER TREMPÉ ZINGUÉ CONIC HEAD HARDENED STEEL NAIL ZINC PLATED																	
																	
1,20x25					2224	110	12	0,900						52235	1000	54	4,700
1,50x20	4859	110	10	0,730	2224	110	12	0,900						5224	1000	54	5,636
1,50x25					22243	90	12	0,900						52243	1000	54	6,484
1,50x30														52245	1000	27	7,653
2x25					2225	65	12	0,900						5225	500	54	3,264
2x30					22253	45	12	0,900						52253	500	54	3,586
2x35	4860	45	10	0,730	2226	45	12	0,900						5226	500	27	4,341
2x40					22263	30	12	0,900						52263	500	27	4,471
2x45					2227	30	12	0,900						5227	500	27	5,423
2x50														52273	500	18	5,791
<b>PUNTA DE ACERO</b> <b>CABEZA CÓNICA</b> COBREDO POINTE TÊTE HOMME ACIER TREMPÉ CUIVRÉ CONIC HEAD HARDENED STEEL NAIL COPPER PLATED																	
																	
1,50x20	4861	100	10	0,730	2230	100	12	0,900	43340	800	48	12	3,279	5230	1000	54	5,988
1,50x25	4862	90	10	0,730	22305	90	12	0,900	43341	600	24	8	3,279	52305	1000	54	6,896
2x25	4863	55	10	0,730	2231	65	12	0,900	43342	400	48	12	3,279	5231	500	54	3,772
2x30	4864	45	10	0,730	22315	45	12	0,900	43343	350	24	8	3,279	52315	500	54	4,300
2x35	4865	45	10	0,730	2232	45	12	0,900	43344	300	24	8	3,279	5232	500	27	5,201
2x40	4866	30	10	0,730	22325	30	12	0,900	43624	250	24	8	3,279	52325	500	27	5,419
2x45	4885	25	10	0,730	2233	30	12	0,900						5233	500	27	6,387
2x50														52335	500	18	6,775
<b>PUNTA DE ACERO</b> <b>CABEZA CÓNICA</b> LATONADO POINTE TÊTE HOMME ACIER TREMPÉ LAITONNÉ CONIC HEAD HARDENED STEEL NAIL BRASS PLATED																	
																	
1,50x20					2235	100	12	0,900						5235	1000	54	6,548
1,50x25					22352	70	12	0,900						52352	1000	54	7,556
2x25					22354	50	12	0,900						52354	500	54	4,390
2x30					22356	45	12	0,900						52356	500	54	5,026
2x35					22358	40	12	0,900						52358	500	27	6,077
2x40														5236	500	27	6,507
2x45					22362	30	12	0,900						52362	500	27	7,505
2x50														52365	500	18	8,053
<b>PUNTA DE ACERO</b> <b>CABEZA ANCHA</b> ZINCADO POINTE TÊTE LARGE ACIER TREMPÉ ACIER ZINGUÉ FLAT LARGE HEAD HARDENED STEEL NAIL ZINC PLATED																	
																	
2,70x25					2237	30	12	0,900						5237	1 kg	18	8,423
2,70x35														52372	1 kg	18	8,274
3x35					22374	16	12	0,900						52374	1 kg	18	8,059
3x40														52375	1 kg	18	7,989
3,40x30														52376	1 kg	18	7,489
3,40x40					22378	14	12	0,900						52378	1 kg	18	7,618
3,40x50														52379	1 kg	18	7,914
<b>PUNTA</b> <b>CABEZA REDONDA</b> LATÓN POINTE TÊTE RONDE LAITON MASSIF ROUND HEAD NAIL SOLID BRASS																	
																	
1,30x12					2239	55	12	0,900									
1,30x20					22391	40	12	0,900									
1,50x16					22392	30	12	0,900									
1,50x25					22393	20	12	0,900									



MEDIDA: DIMENSION / SIZE | Nº PIEZAS: Nº PCS / Nº PCS | UDS. EMBALAJE: U.C. / PACKING | PRECIO TARIFA: PRIX / PRICE

MEDIDA		BOLSA SACHET BAG				PEQUEÑOS TRABAJOS BRICOLAGE D.I.Y.				CAJA PROFESIONAL PLÁSTICO BOÎTE PROFESSIONNELLE PROFESSIONAL BOX					CAJA PROFESIONAL CARTÓN BOÎTE PROFESSIONNELLE CARTON PROFESSIONAL CARTON BOX			
GALGA DE PARÍS	GRUESO (mm)	REF.	Nº PIEZAS	UDS. EMBALAJE	PRECIO TARIFA	REF.	Nº PIEZAS	UDS. EMBALAJE	PRECIO TARIFA	REF.	Nº PIEZAS	UDS. EMBALAJE	UDS. PEDIDO	PRECIO TARIFA	REF.	Nº PIEZAS	UDS. EMBALAJE	PRECIO TARIFA

**PUNTA DE HIERRO**

**CABEZA PLANA**

ZINCADO  
POINTÉ TÊTE PLATE ACIER ZINGUÉ  
FLAT HEAD COMMON IRON NAIL ZINC PLATED



6x15	1,10x15	4867	240	10	0,730	2240	240	12	0,900	43350	250 g	48	12	3,279				
7x18	1,20x18	4868	200	10	0,730	2241	200	12	0,900									
8x20	1,30x20	4869	200	10	0,730	2242	200	12	0,900	43351	250 g	24	8	3,279				
8x25	1,30x25	4870	155	10	0,730					43625	250 g	24	8	3,279				
9x25	1,40x25					22432	155	12	0,900									
9x25	1,40x25					61000	250 g	6	2,425									
10x20	1,50x20					22433	120	12	0,900									
10x30	1,50x30					22434	90	12	0,900									
11x30	1,60x30	4871	85	10	0,730	22442	85	12	0,900	43352	250 g	24	8	3,279				
11x30	1,60x30					61001	250 g	6	2,425									
12x35	1,80x35	41639	55	10	0,730	22452	50	12	0,900									
12x40	1,80x40					61002	250 g	6	2,425									
13x30	2x30					22453	45	12	0,900									
13x35	2x35					22454	45	12	0,900									
13x40	2x40	4872	30	10	0,730	2246	40	12	0,900	43353	250 g	24	8	3,279				
13x50	2x50					22461	35	12	0,900									
14x40	2,20x40	41640	25	10	0,730	22462	35	12	0,900									
14x40	2,20x40					61004	250 g	6	2,425									
14x45	2,20x45					2247	25	12	0,900									
15x50	2,40x50	4873	15	10	0,730	2249	25	12	0,900	43354	250 g	24	8	3,279				
15x50	2,40x50					61006	250 g	6	2,425									
15x55	2,40x55					61007	250 g	6	2,425									
16x55	2,70x55					22494	25	12	0,900									
16x60	2,70x60					22496	20	12	0,900	43355	250 g	24	8	3,279				
16x60	2,70x60					61008	250 g	6	2,425									
17x60	3x60					2250	15	12	0,900	43356	250 g	24	8	3,279				
17x70	3x70					22504	15	10A	1,778	43357	250 g	24	8	3,279				
17x70	3x70					61009	250 g	6	2,425									
18x70	3,40x70									43358	250 g	80	10	3,279				
18x80	3,40x80									43359	250 g	80	10	3,279				
18x80	3,40x80					61010	250 g	6	2,425									
19x80	3,90x80					2251	11	10A	2,533	43360	250 g	24	8	3,279				
19x90	3,90x90									43361	250 g	20	10	3,279				
19x90	3,90x90					61011	250 g	6	2,425									
20x100	4,40x100					22514	7	10A	2,533	43362	250 g	20	10	3,279				
20x100	4,40x100					61012	250 g	6	2,425									
21x110	4,90x110					61013	250 g	6	2,425									
21x120	4,90x120					22518	6	10A	2,533	43363	250 g	20	10	3,279				
22x120	5,40x120					61014	250 g	6	2,425									

**PUNTA DE HIERRO**

**CABEZA PLANA**

PULIDO  
POINTÉ TÊTE PLATE ACIER BRUT  
FLAT HEAD COMMON IRON NAIL PLAIN



6x15	1,10x15	● 41520	130 g	10	1,806										5241	2,5 kg	10	13,600
7x18	1,20x18														5242	2,5 kg	10	13,600
8x20	1,30x20	● 41521	140 g	10	1,806	22550	200	12	0,900					52421	2,5 kg	10	12,350	
9x20	1,40x20													52433	2,5 kg	10	12,350	
10x20	1,50x20													52435	2,5 kg	10	12,350	
10x25	1,50x25	● 41522	150 g	10	1,806	22435	155	12	0,900					52441	2,5 kg	10	12,350	
11x27	1,60x27													52442	2,5 kg	10	12,350	
11x30	1,60x30	● 41523	175 g	10	1,806									52446	2,5 kg	10	10,850	
12x25	1,80x25													5245	2,5 kg	10	10,850	
12x30	1,80x30													52452	2,5 kg	10	10,850	
12x35	1,80x35	● 41524	200 g	10	1,806									52455	2,5 kg	10	10,850	
12x40	1,80x40													52453	2,5 kg	10	10,100	
13x30	2x30	● 41525	200 g	10	1,806	22552	45	12	0,900					52454	2,5 kg	10	10,100	
13x35	2x35																	



MEDIDA: DIMENSION / SIZE | Nº PIEZAS: Nº PCS / Nº PCS | UDS. EMBALAJE: U.C. / PACKING | PRECIO TARIFA: PRX / PRICE

MEDIDA		BOLSA SACHET BAG				PEQUEÑOS TRABAJOS BRICOLAGE D.I.Y.				CAJA PROFESIONAL PLÁSTICO BOÎTE PROFESSIONNELLE PROFESSIONAL BOX					CAJA PROFESIONAL CARTÓN BOÎTE PROFESSIONNELLE CARTON PROFESSIONAL CARTON BOX				
GALGA DE PARÍS	GRUESO (mm)	REF.	Nº PIEZAS	UDS. EMBALAJE	PRECIO TARIFA	REF.	Nº PIEZAS	UDS. EMBALAJE	PRECIO TARIFA	REF.	Nº PIEZAS	UDS. EMBALAJE	UDS. PEDIDO	PRECIO TARIFA	REF.	Nº PIEZAS	UDS. EMBALAJE	PRECIO TARIFA	
<b>PUNTA DE HIERRO</b>																			
<b>CABEZA PLANA</b>																			
PULIDO POINTE TÊTE PLATE ACIER BRUT FLAT HEAD COMMON IRON NAIL PLAIN																			
13x40	2x40	● 41526	200 g	10	1,806										5246	2,5 kg	10	10,100	
14x40	2,20x40														52462	2,5 kg	10	10,100	
14x45	2,20x45														5247	2,5 kg	10	10,100	
15x50	2,40x50	● 41527	200 g	10	1,806	22553	25	12	0,900						5249	2,5 kg	10	10,100	
15x55	2,40x55														52491	2,5 kg	10	10,100	
16x60	2,70x60	● 41528	200 g	10	1,806										52496	2,5 kg	10	9,850	
17x60	3x60					22554	15	12	0,900						5250	2,5 kg	10	9,850	
17x70	3x70	● 41529	200 g	10	1,806										52504	2,5 kg	10	9,850	
18x80	3,40x80	● 41530	200 g	10	1,806										52508	2,5 kg	10	9,850	
19x70	3,90x70														52510	2,5 kg	10	9,850	
19x80	3,90x80					22556	11	10	3,333										
19x90	3,90x90	● 41531	200 g	10	1,806										52512	2,5 kg	10	9,850	
20x100	4,40x100	● 41532	200 g	10	1,806	22557	7	10	3,333						52514	2,5 kg	10	9,850	
20x120	4,40x120					22558	6	10	3,333										
21x110	4,90x110														52524	2,5 kg	10	9,850	
22x120	5,40x120														52525	2,5 kg	10	9,850	
22x130	5,40x130														52526	2,5 kg	10	9,850	
23x140	5,90x140														52527	2,5 kg	10	9,850	
23x150	5,90x150														52528	2,5 kg	10	9,850	
24x140	6,40x140														52529	2,5 kg	10	10,100	
24x150	6,40x150														5254	2,5 kg	10	10,100	
24x160	6,40x160														52541	2,5 kg	10	10,100	
24x180	6,40x180														52542	2,5 kg	10	10,100	
25x200	7x200														52543	2,5 kg	10	10,100	
<b>PUNTA DE HIERRO</b>																			
<b>CABEZA CÓNICA</b>																			
ZINCADO POINTE TÊTE HOMME ACIER ZINGUÉ CONIC HEAD COMMON IRON NAIL ZINC PLATED																			
4x16	0,90x16					22599	300	12	0,900										
6x15	1,10x15	4874	200	10	0,730	2260	200	12	0,900	43370	250 g	48	12	3,279					
7x18	1,20x18	41641	180	10	0,730	2261	170	12	0,900	43626	250 g	48	12	3,279					
8x20	1,30x20					22611	165	12	0,900										
9x22	1,40x22	4875	165	10	0,730	2262	165	12	0,900	43371	250 g	48	12	3,279					
10x25	1,50x25					22621	140	12	0,900										
10x30	1,50x30					22622	130	12	0,900										
10x40	1,50x40					22623	80	12	0,900										
11x27	1,60x27	4876	100	10	0,730	2263	100	12	0,900	43372	250 g	24	8	3,279					
12x30	1,80x30					61017	250 g	6	2,425										
12x35	1,80x35					2264	55	12	0,900	43627	250 g	24	8	3,279					
13x40	2x40	4877	45	10	0,730	2265	45	12	0,900	43373	250 g	24	8	3,279					
14x45	2,20x45					2266	40	12	0,900										
15x50	2,40x50					2267	37	12	0,900										
15x55	2,40x55					22671	25	12	0,900										
<b>PUNTA DE HIERRO</b>																			
<b>CABEZA CÓNICA</b>																			
PULIDO POINTE TÊTE HOMME ACIER BRUT CONIC HEAD COMMON IRON NAIL PLAIN																			
6x15	1,10x15	● 41540	130 g	10	1,806														
8x20	1,30x20					22680	165	12	0,900										
9x22	1,40x22	● 41541	150 g	10	1,806														
10x25	1,50x25					22681	140	12	0,900										
11x27	1,60x27	● 41542	150 g	10	1,806	22682	130	12	0,900										
12x35	1,80x35	● 41543	160 g	10	1,806	22683	55	12	0,900										
13x40	2x40	● 41544	160 g	10	1,806	22684	45	12	0,900										
15x55	2,40x55	● 41545	160 g	10	1,806														
<b>PUNTA VIDRIERA</b>																			
ZINCADO POINTE VITRIER ACIER ZINGUÉ CONIC HEAD COMMON IRON NAIL ZINC PLATED																			
8x18	1,30x18	41642	150	10	0,730	22695	165	12	0,900										

● Se vende en bolsa amarilla



MEDIDA: DIMENSION / SIZE | Nº PIEZAS: Nº PCS / Nº PCS | UDS. EMBALAJE: U.C. / PACKING | PRECIO TARIFA: PRIX / PRICE

MEDIDA	BOLSA SACHET BAG				PEQUEÑOS TRABAJOS BRICOLAGE D.I.Y.				CAJA PROFESIONAL PLÁSTICO BOÎTE PROFESSIONNELLE PROFESSIONAL BOX					CAJA PROFESIONAL CARTÓN BOÎTE PROFESSIONNELLE CARTON PROFESSIONAL CARTON BOX			
	REF.	Nº PIEZAS	UDS. EMBALAJE	PRECIO TARIFA	REF.	Nº PIEZAS	UDS. EMBALAJE	PRECIO TARIFA	REF.	Nº PIEZAS	UDS. EMBALAJE	UDS. PEDIDO	PRECIO TARIFA	REF.	Nº PIEZAS	UDS. EMBALAJE	PRECIO TARIFA

**PUNTA DE HIERRO ROSCADA**

**CABEZA PLANA**

**ZINCADO**

POINTE TORSADÉE TÊTE PLATE ACIER ZINGUÉ  
FLAT HEAD SCREW NAIL ZINC PLATED



2,50x50					2270	20	12	0,900									
---------	--	--	--	--	------	----	----	-------	--	--	--	--	--	--	--	--	--

**GRAPA DE POLIETILENO**

**BLANCO**

ATTACHE  
PLASTIQUE BLANC  
CABLE CLIP WHITE



3,9x2,2	4878	10	10	0,730	2281	10	12	0,900	43629	45	160	10	3,279	5281	100	54	5,031
5,4x3,3	4879	9	10	0,730	2282	9	12	0,900	43630	35	160	10	3,279	5282	100	54	5,065
7,3x4,1	41643	8	10	0,730	2283	8	12	0,900						5283	100	54	5,237
9,3x5					22833	7	12	0,900						52833	100	27	6,020

**GRAPA DE POLIETILENO**

**BLANCO**

ATTACHE PLASTIQUE  
BLANC  
CABLE CLIP WHITE



4 mm					22835	12	12	0,900									
5 mm	4880	9	10	0,730	2284	9	12	0,900	43380	150	24	8	3,279	5284	100	12	2,694
6 mm	4881	8	10	0,730	2285	8	12	0,900	43381	125	24	8	3,279	5285	100	12	2,807
7 mm	4882	8	10	0,730	2286	8	12	0,900	43382	100	24	8	3,279	5286	100	12	3,307
8 mm	4883	8	10	0,730	2287	8	12	0,900	43383	100	24	8	3,279	5287	100	12	3,307
9 mm	4884	6	10	0,730	2288	8	12	0,900	43384	80	24	8	3,279	5288	100	12	3,542
10 mm					2289	6	12	0,900	43628	50	24	8	3,279	5289	100	12	3,851
12 mm					22893	4	12	0,900						52893	100	12	4,864
14 mm														52894	100	9	11,863
17 mm														52895	100	9	13,194

○ Se vende en bolsa.











MEDIDA: DIMENSION / SIZE | Nº PIEZAS: Nº PCS / Nº PCS | UDS. EMBALAJE: U.C. / PACKING | PRECIO TARIFA: PRIX / PRICE

MEDIDA	BOLSA SACHET BAG				PEQUEÑOS TRABAJOS BRICOLAGE D.I.Y.				CAJA PROFESIONAL PLÁSTICO BOÎTE PROFESSIONNELLE PROFESSIONAL BOX					CAJA PROFESIONAL CARTÓN BOÎTE PROFESSIONNELLE CARTON PROFESSIONAL CARTON BOX			
	REF.	Nº PIEZAS	UDS. EMBALAJE	PRECIO TARIFA	REF.	Nº PIEZAS	UDS. EMBALAJE	PRECIO TARIFA	REF.	Nº PIEZAS	UDS. EMBALAJE	UDS. PEDIDO	PRECIO TARIFA	REF.	Nº PIEZAS	UDS. EMBALAJE	PRECIO TARIFA
<b>GRAPA DE POLIETILENO</b>																	
GRIS ATTACHE PLASTIQUE GRIS CABLE CLIP GREY																	
6 mm					22952	8	12	0,900									
7 mm					22953	8	12	0,900									
8 mm					22954	8	12	0,900									
<b>GRAPA DE POLIETILENO</b>																	
TRANSPARENTE ATTACHE PLASTIQUE TRANSPARENT CABLE CLIP TRANSPARENT																	
6,8 mm	41485	5	10	0,730	2290	8	12	0,900	43631	30	48	12	3,279	5290	100	27	7,297
<b>GRAPA DE POLIETILENO</b>																	
BLANCO ATTACHE PLASTIQUE BLANC CABLE CLIP WHITE																	
0-0					2280	12	12	0,900									
<b>GRAPA DE POLIETILENO</b>																	
BLANCO ATTACHE PLASTIQUE BLANC CABLE CLIP WHITE																	
0-1					2297	10	12	0,900									
<b>GRAMPILLÓN</b>																	
ZINCADO CRAMPILLON ACIER ZINGUÉ STAPLE ZINC PLATED																	
8x12					2299	180	12	0,900									
9x14	4887	90	10	0,730	2300	110	12	0,900									
10x14	4888	85	10	0,730	23005	85	12	0,900	43632	400	48	12	3,279				
11x18	4889	45	10	0,730	2301	45	12	0,900	43633	300	48	12	3,279				
12x20	41644	40	10	0,730	23012	45	12	0,900									
13x18	41486	40	10	0,730	23014	45	12	0,900	43634	200	48	12	3,279				
15x22					23018	20	12	0,900									
16x27					2302	15	12	0,900									









MEDIDA: DIMENSION / SIZE | Nº PIEZAS: Nº PCS / Nº PCS | UDS. EMBALAJE: U.C. / PACKING | PRECIO TARIFA: PRIX / PRICE

MEDIDA	BOLSA SACHET BAG				PEQUEÑOS TRABAJOS BRICOLAGE D.I.Y.				CAJA PROFESIONAL PLÁSTICO BOÎTE PROFESSIONNELLE PROFESSIONAL BOX					CAJA PROFESIONAL CARTÓN BOÎTE PROFESSIONNELLE CARTON PROFESSIONAL CARTON BOX			
	REF.	Nº PIEZAS	UDS. EMBALAJE	PRECIO TARIFA	REF.	Nº PIEZAS	UDS. EMBALAJE	PRECIO TARIFA	REF.	Nº PIEZAS	UDS. EMBALAJE	UDS. PEDIDO	PRECIO TARIFA	REF.	Nº PIEZAS	UDS. EMBALAJE	PRECIO TARIFA
<b>SEMENCE ZAPATERO</b>																	
BICROMATADO SEMENCE CHAUSSURE ACIER BICHROMATÉ SHOE TACKS YELLOW ZINC PLATED 																	
12 mm					2304	80	12	1,353									
<b>SEMENCE</b>																	
ZINCADO SEMENCE TAPISSIER ACIER ZINGUÉ UPHOLSTERY TACKS ZINC PLATED 																	
10 mm	4890	120	10	0,730	2310	150	12	0,900									
14 mm	4891	100	10	0,730	2311	120	12	0,900									
<b>TACHUELA</b>																	
NEGRA SEMENCE TAPISSIER ACIER BLEUI CUT TACKS BLUED 																	
4x8					23133	100	12	0,900						53133	4000	54	10,784
6x10					23134	55	12	0,900						53134	2200	54	12,442
8x12					23135	55	12	0,900						53135	1900	54	12,342
10x14	41487	40	10	0,730	23136	40	12	0,900						53136	1700	27	12,746
12x16					23137	30	12	0,900						53137	1000	54	7,856
14x18					23138	25	12	0,900						53138	700	54	6,963
<b>TACHUELA</b>																	
CLOU TAPISSIER FURNITURE NAIL 																	
8 Latonado					23199	30	12	0,900									
9,5 Niquelado	4892	20	10	0,730	2320	20	12	0,900									
9,5 Latonado	4893	20	10	0,730	2321	20	12	0,900									
10 Latonado					23211	20	12	0,900									
10 Oro Viejo					23212	20	12	0,900									
<b>MARGARITA</b>																	
CLOU TAPISSIER DÉCORATIF DECORATIVE FURNITURE NAIL 																	
12 Latonado	4894	7	10	0,730	23213	10	12	0,900									
12 Niquelado					23214	10	12	0,900									
20 Latonado					23217	5	10	0,900									
<b>HERRAJE</b>																	
PAVONADO CLOU TAPISSIER ACIER NOIR FANCY NAIL BLACK 																	
11 mm					23216	8	12	0,900									
<b>HERRAJE MARTELÉ</b>																	
PAVONADO CLOU TAPISSIER MARTELÉ ACIER NOIR FANCY NAIL BLACK 																	
20 mm					23218	5	10	0,900									

- LATONADO | LAITONNÉ | BRASS PLATED
- NIQUELADO | NICKELÉ | NICKEL-PLATED
- ORO VIEJO | ACIER VIEILLI | ANTIQUED STEEL



MEDIDA: DIMENSION / SIZE | Nº PIEZAS: Nº PCS / Nº PCS | UDS. EMBALAJE: U.C. / PACKING | PRECIO TARIFA: PRIX / PRICE

MEDIDA	BOLSA SACHET BAG				PEQUEÑOS TRABAJOS BRICOLAGE D.I.Y.				CAJA PROFESIONAL PLÁSTICO BOÎTE PROFESSIONNELLE PROFESSIONAL BOX					CAJA PROFESIONAL CARTÓN BOÎTE PROFESSIONNELLE CARTON PROFESSIONAL CARTON BOX			
	REF.	Nº PIEZAS	UDS. EMBALAJE	PRECIO TARIFA	REF.	Nº PIEZAS	UDS. EMBALAJE	PRECIO TARIFA	REF.	Nº PIEZAS	UDS. EMBALAJE	UDS. PEDIDO	PRECIO TARIFA	REF.	Nº PIEZAS	UDS. EMBALAJE	PRECIO TARIFA
<b>ALFILER DE PRESIÓN</b> PUNAISE SIGNALÉTIQUE / PUSH PIN 	Rojo	4895	10	10	0,730	2322	10	12	0,900								
	Azul					23220	10	12	0,900								
	Verde	4896	10	10	0,730	23221	10	12	0,900								
	Blanco	4897	10	10	0,730	23222	10	12	0,900								
	Surtido					23223	10	12	0,900								
<b>CHINCHETA</b> PUNAISE / THUMB TACK 	Niquelada	4898	35	10	0,730	2330	35	12	0,900								
	Latonada					23301	35	12	0,900								
	Verde	4899	25	10	0,730	2331	35	12	0,900								
	Roja	4900	25	10	0,730	2332	35	12	0,900								
	Amarilla	4901	25	10	0,730	2333	35	12	0,900								
	Surtido					23330	35	12	0,900								
	Blanca	4902	25	10	0,730	23331	35	12	0,900								
Azul					23332	35	12	0,900									
<b>IMÁN</b> AIMANT / MAGNET 	Surtido 20 mm					26343	2	12	3,333								
	Blanco 30 mm					26344	1	12	3,333								
	Azul 30 mm					26345	1	12	3,333								
<b>CUELGACUADROS DE CHAPA</b> CROCHET TABLEAU / SAW TOOTH HANGER 	Latonado					23335	10	12	0,900								
<b>GANCHO CUELGACUADROS</b> LATONADO CROCHET TABLEAU POINTE TREMPÉ ACIER LAITONNÉ PICTURE HOOK HARDENED NAIL BRASS PLATED 	Num.0	41602	8	10	0,730	23339	8	12	0,900								
	Num.1	41603	7	10	0,730	2334	7	12	0,900								
	Num.2	41604	6	10	0,730	23340	6	12	0,900								
<b>GANCHO CUELGACUADROS</b> LATONADO CROCHET TABLEAU POINTE TREMPÉ ACIER LAITONNÉ PICTURE HOOK HARDENED NAIL BRASS PLATED 	Num.3	41605	3	10	0,730	23341	3	10	0,900					53341	75	27	7,523

- AZUL | BLEU | BLUE
- BLANCO | BLANC | WHITE
- NIQUELADO | NICKELÉ | NICKEL-PLATED

- ROJO | ROUGE | RED
- SURTIDO | ASSORTI | ASSORTMENT
- VERDE | VERT | GREEN

- AMARILLO | JAUNE | YELLOW



MEDIDA: DIMENSION / SIZE | Nº PIEZAS: Nº PCS / Nº PCS | UDS. EMBALAJE: U.C. / PACKING | PRECIO TARIFA: PRIX / PRICE

MEDIDA	BOLSA SACHET BAG				PEQUEÑOS TRABAJOS BRICOLAGE D.I.Y.				CAJA PROFESIONAL PLÁSTICO BOÎTE PROFESSIONNELLE PROFESSIONAL BOX					CAJA PROFESIONAL CARTÓN BOÎTE PROFESSIONNELLE CARTON PROFESSIONAL CARTON BOX			
	REF.	Nº PIEZAS	UDS. EMBALAJE	PRECIO TARIFA	REF.	Nº PIEZAS	UDS. EMBALAJE	PRECIO TARIFA	REF.	Nº PIEZAS	UDS. EMBALAJE	UDS. PEDIDO	PRECIO TARIFA	REF.	Nº PIEZAS	UDS. EMBALAJE	PRECIO TARIFA

**GANCHO CUELGACUADROS**

LATONADO  
CROCHET TABLEAU  
POINTE TREMPÉ  
ACIER LAITONNÉ  
PICTURE HOOK  
HARDENED NAIL  
BRASS PLATED



Num.4	41606	1	10	0,730	23342	1	10	0,900									
-------	-------	---	----	-------	-------	---	----	-------	--	--	--	--	--	--	--	--	--

**CUELGACUADROS**

LATONADO  
ATTACHE  
TRIANGULAIRE  
ACIER LAITONNÉ  
PICTURE HANGER  
BRASS PLATED



6x6	41607	12	10	0,730	23336	12	12	0,900					53336	400	54	16,274
10x10	41608	10	10	0,730	23344	10	12	0,900					53344	300	54	12,603
14x14	41609	6	10	0,730	23345	6	12	0,900					53345	200	54	11,914
16x16	41610	5	10	0,730	23337	5	12	0,900					53337	100	54	11,763
20x20													53338	90	27	11,851

**GANCHO CUELGACUADROS DE CLAVAR**

LATONADO  
CROCHET À CLOUER  
ACIER LAITONNÉ  
PICTURE HOOK  
BRASS PLATED



Num.2					23346	2	12	0,900									
Num.3					23347	1	10	0,900									

**GANCHO PEQUEÑO DE CLAVAR**

CROCHET SUÉDOIS / PICTURE HOOK



20 mm	41611	4	10	0,730	23348	9	12	1,353									
-------	-------	---	----	-------	-------	---	----	-------	--	--	--	--	--	--	--	--	--

**GANCHO CUELGACUADROS DE CLAVAR**

CROCHET SUÉDOIS / PICTURE HOOK



30 mm	41612	3	10	0,730	23349	2	10	0,900					53349	50	54	9,267
40 mm	41613	2	10	0,730	2335	2	10	0,900					5335	40	27	9,414



MEDIDA: DIMENSION / SIZE | N° PIEZAS: N° PCS / N° PCS | UDS. EMBALAJE: U.C. / PACKING | PRECIO TARIFA: PRIX / PRICE

MEDIDA	BOLSA SACHET BAG				PEQUEÑOS TRABAJOS BRICOLAGE D.I.Y.				CAJA PROFESIONAL PLÁSTICO BOÎTE PROFESSIONNELLE PROFESSIONAL BOX					CAJA PROFESIONAL CARTÓN BOÎTE PROFESSIONNELLE CARTON PROFESSIONAL CARTON BOX			
	REF.	N° PIEZAS	UDS. EMBALAJE	PRECIO TARIFA	REF.	N° PIEZAS	UDS. EMBALAJE	PRECIO TARIFA	REF.	N° PIEZAS	UDS. EMBALAJE	UDS. PEDIDO	PRECIO TARIFA	REF.	N° PIEZAS	UDS. EMBALAJE	PRECIO TARIFA

**GANCHO CUELGACUADRO DECORATIVO**

CROCHET DÉCORATIF / HOOK



32 mm Oro viejo					23352	1	10	1,353									
--------------------	--	--	--	--	-------	---	----	-------	--	--	--	--	--	--	--	--	--

**COLGADOR DE TELA ADHESIVO**

ATTACHE TABLEAU TOILE GOMMÉE  
ADHESIVE HOOK



30 mm	41614	3	10	0,730	23356	7	12	1,778									
45 mm	41615	2	10	0,730	23357	4	12	1,353									

**GANCHO CORTINA**

CROCHET À RIDEAUX BLANC  
CURTAIN HOOK WHITE



Blanco	41616	3	10	0,730	23361	4	12	0,900									
--------	-------	---	----	-------	-------	---	----	-------	--	--	--	--	--	--	--	--	--

**CUELGAFÁCIL CON PROTECTOR**

CROCHET PLASTIQUE AVEC PROTECTEUR  
NYLON HOOK



	41638	15	10	1,068	23363	15	12	1,353									
--	-------	----	----	-------	-------	----	----	-------	--	--	--	--	--	--	--	--	--

**UÑA DE ACERO**

ZINCADO  
GOND À POINTE ACIER TREMPÉ ZINGUÉ  
HARDENED STEEL PIN ZINC PLATED



2,25x19					2340	30	12	0,900					5340	300	54	3,752
2,25x23	4886	28	10	0,730	2341	28	12	0,900					5341	300	54	4,670
2,25x26					2342	21	12	0,900					5342	300	54	4,810

- BLANCO | BLANC | WHITE
- ORO VIEJO | ACIER VIEILLI | ANTIQUED STEEL



MEDIDA: DIMENSION / SIZE | Nº PIEZAS: Nº PCS / Nº PCS | UDS. EMBALAJE: U.C. / PACKING | PRECIO TARIFA: PRIX / PRICE

MEDIDA	BOLSA SACHET BAG				PEQUEÑOS TRABAJOS BRICOLAGE D.I.Y.				CAJA PROFESIONAL PLÁSTICO BOÎTE PROFESSIONNELLE PROFESSIONAL BOX					CAJA PROFESIONAL CARTÓN BOÎTE PROFESSIONNELLE CARTON PROFESSIONAL CARTON BOX			
	REF.	Nº PIEZAS	UDS. EMBALAJE	PRECIO TARIFA	REF.	Nº PIEZAS	UDS. EMBALAJE	PRECIO TARIFA	REF.	Nº PIEZAS	UDS. EMBALAJE	UDS. PEDIDO	PRECIO TARIFA	REF.	Nº PIEZAS	UDS. EMBALAJE	PRECIO TARIFA
2,10x7					2444	32	12	1,353									
2,10x12					2446	45	12	0,900									
2,10x16					2448	37	12	0,900									
2,50x10					2449	40	12	0,900									
2,50x16					24502	30	12	0,900	43400	425	48	12	3,279				
2,50x20					24504	30	12	0,900									
3x12					24506	30	12	0,900									
3x16					24508	30	12	0,900									
3x20	41488	30	10	0,730	2451	30	12	0,900	43401	275	48	12	3,279				
3x25					24511	30	12	0,900									
3x30					24512	20	12	0,900									
3x35					24514	20	12	0,900									
3,50x16	41646	30	10	0,730	24518	30	12	0,900	43402	250	48	12	3,279				
3,50x20	41489	25	10	0,730	24519	25	12	0,900	43635	200	48	12	3,279				
3,50x25	41647	20	10	0,730	2452	17	12	0,900	43403	175	48	12	3,279				
3,50x30	41648	20	10	0,730	24521	20	12	0,900	43636	150	24	8	3,279				
3,50x35					24523	15	12	0,900									
3,50x40					24525	15	12	0,900									
4x20					24527	18	12	0,900									
4x25					24529	15	12	0,900									
4x30	41649	20	10	0,730	2453	12	12	0,900	43404	125	24	8	3,279				
4x35	41490	12	10	0,730	24535	12	12	0,900									
4x40	41491	12	10	0,730	2454	9	12	0,900	43405	100	24	8	3,279				
4x50					24541	8	12	0,900									
4,50x20					24543	15	12	0,900									
4,50x30					24546	15	12	0,900									
4,50x40	41492	7	10	0,730	24549	10	12	0,900	43406	80	24	8	3,279				
4,50x50	41493	7	10	0,730	2455	10	12	0,900	43407	65	24	8	3,279				
5x30					24552	10	12	0,900									
5x40					24554	9	12	0,900									
5x50					24556	7	12	0,900	43408	50	24	8	3,279				
5x60					2456	7	12	0,900	43409	40	24	8	3,279				

**TORNILLO PARA AGLOMERADO Y MADERA**

**CABEZA PLANA POZI**

**ZINCADO**

VIS AGGLO TÊTE FRAISÉE POZI ACIER ZINGUÉ  
FLAT HEAD POZI CHIPBOARD SCREW ZINC PLATED





MEDIDA: DIMENSION / SIZE | Nº PIEZAS: Nº PCS / Nº PCS | UDS. EMBALAJE: U.C. / PACKING | PRECIO TARIFA: PRIX / PRICE

MEDIDA	BOLSA SACHET BAG				PEQUEÑOS TRABAJOS BRICOLAGE D.I.Y.				CAJA PROFESIONAL PLÁSTICO BOÎTE PROFESSIONNELLE PROFESSIONAL BOX				CAJA PROFESIONAL CARTÓN BOÎTE PROFESSIONNELLE CARTON PROFESSIONAL CARTON BOX				
	REF.	Nº PIEZAS	UDS. EMBALAJE	PRECIO TARIFA	REF.	Nº PIEZAS	UDS. EMBALAJE	PRECIO TARIFA	REF.	Nº PIEZAS	UDS. EMBALAJE	UDS. PEDIDO	PRECIO TARIFA	REF.	Nº PIEZAS	UDS. EMBALAJE	PRECIO TARIFA
2,50x10	4903	40	10	0,730	24573	40	12	0,900	43420	500	48	12	3,279	54573	1000	54	5,328
2,50x16	4904	30	10	0,730	24574	30	12	0,900	43421	425	48	12	3,279	54574	1000	27	6,131
2,50x20	4905	30	10	0,730	24575	30	12	0,900	43422	325	48	12	3,279	54575	1000	27	6,728
2,50x25	4906	25	10	0,730	24576	25	12	0,900						54576	1000	27	7,345
3x12	4927	30	10	0,730	24577	30	12	0,900	43424	300	48	12	3,279	54577	1000	27	6,295
3x16	4907	30	10	0,730	24578	30	12	0,900	43425	300	48	12	3,279	54578	1000	27	7,161
3x20	4908	30	10	0,730	24579	30	12	0,900	43426	275	48	12	3,279	54579	1000	18	8,865
3x25	4909	30	10	0,730	2458	30	12	0,900	43427	200	48	12	3,279	5458	1000	18	9,273
3x30	4910	20	10	0,730	24581	20	12	0,900	43428	150	48	12	3,279	54581	1000	18	10,745
3x35	4938	20	10	0,730	24582	20	12	0,900	43429	150	24	8	3,279	54582	1000	9	12,492
3x40					24580	16	12	0,900	43430	130	24	8	3,279	54580	1000	9	13,868
3,50x16	4911	30	10	0,730	24583	30	12	0,900	43431	250	48	12	3,279	54583	1000	18	8,997
3,50x20	4912	25	10	0,730	24584	25	12	0,900	43432	200	48	12	3,279	54584	1000	18	10,101
3,50x25	4913	20	10	0,730	24585	17	12	0,900	43433	200	24	8	3,279	54585	1000	18	11,337
3,50x30	4914	17	10	0,730	24586	20	12	0,900	43434	150	24	8	3,279	54586	1000	9	12,860
3,50x35	4939	15	10	0,730	24587	15	12	0,900	43435	130	24	8	3,279	54587	1000	9	14,372
3,50x40	4915	15	10	0,730	24589	15	12	0,900	43436	120	24	8	3,279	54589	1000	9	15,972
3,50x45					24600	10	12	0,900	43637	100	24	8	3,279	54600	700	9	13,655
3,50x50					24588	10	12	0,900	43437	75	24	8	3,279	54588	600	9	12,280
4x16					24590	22	12	0,900	43438	190	48	12	3,279	54590	1000	18	10,745
4x20	4916	18	10	0,730	2459	18	12	0,900	43439	165	48	12	3,279	5459	1000	9	12,216
4x25	4917	15	10	0,730	24591	15	12	0,900	43440	125	48	12	3,279	54591	1000	9	13,776
4x30	4918	14	10	0,730	24592	12	12	0,900	43441	125	24	8	3,279	54592	1000	9	15,056
4x35	4919	12	10	0,730	24593	12	12	0,900	43442	110	24	8	3,279	54593	1000	9	16,892
4x40	4920	12	10	0,730	24594	9	12	0,900	43443	100	24	8	3,279	54594	500	9	10,196
4x45					24610	8	12	0,900	43444	85	24	8	3,279	54610	500	9	11,160
4x50					24611	8	12	0,900	43445	80	24	8	3,279	54611	500	9	12,146
4x60					24613	7	12	0,900	43411	60	24	8	3,279	54613	400	9	11,537
4x70					24624	5	12	0,900	43638	55	24	8	3,279	54624	350	9	15,137
4,50x20	4921	26	10	0,730	24595	15	12	0,900	43446	125	48	12	3,279	54595	1000	9	16,227
4,50x25					24625	15	12	0,900	43639	90	48	12	3,279	54625	1000	9	16,682
4,50x30	4922	15	10	0,730	24596	15	12	0,900	43448	80	48	12	3,279	54596	1000	9	19,232
4,50x35					24614	13	12	0,900	43413	60	48	12	3,279	54614	800	9	17,646
4,50x40	4923	7	10	0,730	24597	12	12	0,900	43449	70	24	8	3,279	54597	500	9	12,764
4,50x45					24615	11	12	0,900	43414	60	24	8	3,279	54615	500	9	13,912
4,50x50	4924	7	10	0,730	24598	10	12	0,900	43450	55	24	8	3,279	54598	400	9	12,472
4,50x60					24616	7	12	0,900	43451	40	24	8	3,279	54616	400	9	14,398
4,50x70					24617	5	12	0,900	43415	40	24	8	3,279	54617	350	9	14,539
5x20					24626	12	12	0,900	43640	100	48	12	3,279	54626	1000	9	18,980
5x30					2460	10	12	0,900	43452	80	24	8	3,279	5460	1000	9	23,452

**TORNILLO PARA AGLOMERADO Y MADERA**

**CABEZA PLANA POZI**

**BICROMATADO**

VIS AGGLO TÊTE FRAISÉE POZI ACIER BICHROMATÉ  
FLAT HEAD POZI CHIPBOARD SCREW YELLOW  
ZINC PLATED





MEDIDA: DIMENSION / SIZE | Nº PIEZAS: Nº PCS / Nº PCS | UDS. EMBALAJE: U.C. / PACKING | PRECIO TARIFA: PRIX / PRICE

MEDIDA	BOLSA SACHET BAG				PEQUEÑOS TRABAJOS BRICOLAGE D.I.Y.				CAJA PROFESIONAL PLÁSTICO BOÎTE PROFESSIONNELLE PROFESSIONAL BOX				CAJA PROFESIONAL CARTÓN BOÎTE PROFESSIONNELLE CARTON PROFESSIONAL CARTON BOX			
	REF.	Nº PIEZAS	UDS. EMBALAJE	PRECIO TARIFA	REF.	Nº PIEZAS	UDS. EMBALAJE	PRECIO TARIFA	REF.	Nº PIEZAS	UDS. EMBALAJE	UDS. PEDIDO	PRECIO TARIFA	REF.	Nº PIEZAS	UDS. EMBALAJE

Continuación de página anterior

**TORNILLO PARA AGLOMERADO Y MADERA**

**CABEZA PLANA POZI**

BICROMATADO  
VIS AGGLO TÊTE FRAISÉE POZI ACIER BICHROMATÉ  
FLAT HEAD POZI CHIPBOARD SCREW YELLOW ZINC PLATED



5x35					24618	9	12	0,900	43417	65	24	8	3,279	54618	500	9	25,278
5x40	4925	7	10	0,730	24601	9	12	0,900	43453	65	24	8	3,279	54601	500	9	15,196
5x45					24619	8	12	0,900	43418	50	24	8	3,279	54619	400	9	13,683
5x50	4926	7	10	0,730	24602	7	12	0,900	43454	50	24	8	3,279	54602	300	9	11,468
5x60	41479	7	10	0,730	24603	7	12	0,900	43455	40	24	8	3,279	54603	200	9	9,316
5x70					24606	5	10A	0,900	43456	35	24	8	3,279	54606	200	9	11,842
5x80					24607	4	10A	1,778	43457	35	24	8	3,279	54607	200	9	14,233
5x90					24608	3	10A	1,778	43458	25	24	8	3,279	54608	150	9	13,250
5x100					24620	3	10A	1,778	43419	20	20	10	3,279	54620	150	9	13,692
6x40					24604	5	12	0,900	43459	40	24	8	3,279	54604	200	9	16,433
6x50					24621	4	12	0,900	43460	35	24	8	3,279	54621	250	9	14,232
6x60	41651	3	10	0,730	24605	3	12	0,900	43461	25	48	12	3,279	54605	200	9	20,428
6x70					24622	3	10A	1,778	43462	20	80	10	3,279	54622	150	9	18,672
6x80					24623	3	10A	1,778	43463	16	80	10	3,279	54623	125	9	13,076
6x90					24609	3	10A	1,778	43464	20	24	8	3,279	54609	120	9	14,676
6x100					2461	3	10A	1,778	43465	15	20	10	3,279	5461	100	9	14,212
6x120					24612	2	10A	1,778	43466	10	20	10	3,279	54612	100	9	17,932

**TORNILLO PARA AGLOMERADO Y MADERA**

**CABEZA PLANA POZI**

LATONADO  
VIS AGGLO TÊTE FRAISÉE POZI ACIER LAITONNÉ  
FLAT HEAD POZI CHIPBOARD SCREW BRASS PLATED



2,50x16					2464	25	12	0,900	43470	350	48	12	3,279				
2,50x25					2466	25	12	0,900									
3x16					2468	20	12	0,900									
3x20					2470	20	12	0,900	43471	250	48	12	3,279				
3x30					24703	20	12	0,900									
3,50x16					24706	15	12	0,900									
3,50x25	41652	20	10	0,730	2471	13	12	0,900	43472	150	48	12	3,279				
3,50x35					24712	15	12	0,900									
3,50x40					24713	13	12	0,900									
4x20					24714	14	12	0,900									
4x30	41495	14	10	0,730	24716	12	12	0,900	43473	125	48	12	3,279				
4x40	41653	12	10	0,730	2472	9	12	0,900	43474	75	24	8	3,279				
4x50					24721	8	12	0,900									

**EMBELLECEDOR PARA TORNILLO MADERA**

**CABEZA PLANA POZI**

CACHE VIS / SCREW COVER



Blanco					2484	18	12	0,900									
Marrón					24841	18	12	0,900									

- BLANCO | BLANC | WHITE
- MARRÓN | MARRON | BROWN





MEDIDA: DIMENSION / SIZE | Nº PIEZAS: Nº PCS / Nº PCS | UDS. EMBALAJE: U.C. / PACKING | PRECIO TARIFA: PRIX / PRICE

MEDIDA	BOLSA SACHET BAG				PEQUEÑOS TRABAJOS BRICOLAGE D.I.Y.				CAJA PROFESIONAL PLÁSTICO BOÎTE PROFESSIONNELLE PROFESSIONAL BOX					CAJA PROFESIONAL CARTÓN BOÎTE PROFESSIONNELLE CARTON PROFESSIONAL CARTON BOX			
	REF.	Nº PIEZAS	UDS. EMBALAJE	PRECIO TARIFA	REF.	Nº PIEZAS	UDS. EMBALAJE	PRECIO TARIFA	REF.	Nº PIEZAS	UDS. EMBALAJE	UDS. PEDIDO	PRECIO TARIFA	REF.	Nº PIEZAS	UDS. EMBALAJE	PRECIO TARIFA

**TORNILLO PARA AGLOMERADO Y MADERA**

**CABEZA REDONDA POZI**

ZINCADO  
VIS AGGLO TÊTE RONDE POZI ACIER ZINGUÉ  
ROUND HEAD POZI CHIPBOARD SCREW ZINC PLATED



2,50x10					2488	40	12	0,900									
2,50x16					2489	25	12	0,900									
3x12					24906	30	12	0,900									
3x20					2491	28	12	0,900									
3x30					24913	20	12	0,900									
3,50x16					24916	25	12	0,900									
3,50x25					2492	17	12	0,900									
3,50x35					24923	15	12	0,900									
4x20					24926	18	12	0,900									
4x30					2493	12	12	0,900									
4x40					2494	8	12	0,900									
4,50x25					2497	15	12	0,900									
4,50x35					2500	10	12	0,900									
4,50x50					2503	8	12	0,900									

**TORNILLO PARA AGLOMERADO Y MADERA**

**CABEZA REDONDA POZI**

BICROMATADO  
VIS AGGLO TÊTE RONDE POZI ACIER BICHROMATÉ  
ROUND HEAD POZI CHIPBOARD SCREW YELLOW ZINC PLATED



2,50x10	4940	40	10	0,730	25043	40	12	0,900						55043	1000	54	22,176
2,50x16	4928	25	10	0,730	25044	25	12	0,900						55044	1000	27	9,233
3x12	4929	30	10	0,730	25046	30	12	0,900						55046	1000	27	34,725
3x20	4930	28	10	0,730	25047	28	12	0,900						55047	1000	18	17,621
3,50x16	4931	25	10	0,730	25049	25	12	0,900						55049	1000	18	14,301
3,50x25	4932	17	10	0,730	2505	17	12	0,900						5505	800	18	35,338
3,50x35	4933	15	10	0,730	25051	15	12	0,900						55051	1000	9	48,292
4x20	4934	18	10	0,730	25052	18	12	0,900						55052	1000	9	44,852
4x30	4935	12	10	0,730	25053	12	12	0,900						55053	1000	9	53,332
4x40	4936	8	10	0,730	25054	8	12	0,900						55054	500	9	36,152
4,50x25	4937	15	10	0,730	25055	15	12	0,900						55055	1000	9	68,772
4,50x50	4941	7	10	0,730	25057	8	12	0,900						55057	400	9	50,996

**TORNILLO PARA AGLOMERADO Y MADERA**

**CABEZA REDONDA POZI**

LATONADO  
VIS AGGLO TÊTE RONDE POZI ACIER LAITONNÉ  
ROUND HEAD POZI CHIPBOARD SCREW BRASS PLATED



2,50x16					2507	18	12	0,900									
3x20					2510	18	12	0,900									
3,50x25					2511	17	12	0,900									
4x40					2512	8	12	0,900									

**TIRAFONDO PARA PLADUR**

NEGRO  
VIS PLAQUE DE PLÂTRE NOIR / DRY WALL SCREW  
TYPE S PHILLIPS BUGLE HEAD BLACK PHOSPHATED



3,50x25	41617	20	10	0,730	2520	17	12	0,900	43480	125	48	12	3,279	5520	1000	9	11,447
3,50x35	41618	15	10	0,730	25202	15	12	0,900	43481	100	24	8	3,279	55202	900	9	13,563
3,50x45	41619	12	10	0,730	25204	12	12	0,900	43482	75	24	8	3,279	55204	600	9	11,419
3,50x55	41620	10	10	0,730	25206	10	12	0,900	43483	60	24	8	3,279	55206	400	9	11,956



MEDIDA: DIMENSION / SIZE | Nº PIEZAS: Nº PCS / Nº PCS | UDS. EMBALAJE: U.C. / PACKING | PRECIO TARIFA: PRIX / PRICE

MEDIDA	BOLSA SACHET BAG				PEQUEÑOS TRABAJOS BRICOLAGE D.I.Y.				CAJA PROFESIONAL PLÁSTICO BOÎTE PROFESSIONNELLE PROFESSIONAL BOX					CAJA PROFESIONAL CARTÓN BOÎTE PROFESSIONNELLE CARTON PROFESSIONAL CARTON BOX			
	REF.	Nº PIEZAS	UDS. EMBALAJE	PRECIO TARIFA	REF.	Nº PIEZAS	UDS. EMBALAJE	PRECIO TARIFA	REF.	Nº PIEZAS	UDS. EMBALAJE	UDS. PEDIDO	PRECIO TARIFA	REF.	Nº PIEZAS	UDS. EMBALAJE	PRECIO TARIFA

**TIRAFONDO ROSCA MADERA**

**CABEZA HEXAGONAL**

**ZINCADO**

TIRAFOND ACIER ZINGUÉ  
HEXAGONAL HEAD WOOD SCREW ZINC PLATED



5x40					26000	4	12	0,900									
5x50					26001	3	12	0,900									
5x60					26002	3	12	0,900									
6x20					26003	5	12	0,900									
6x30					25999	4	12	0,900	43641	40	48	12	3,279	55999	100	27	4,035
6x40	41657	3	10	0,730	2600	3	12	0,900	43476	30	24	8	3,279	5600	100	27	5,833
6x50					2601	3	12	0,900	43642	30	24	8	3,279	5601	100	18	11,641
6x60	41658	3	10	0,730	2602	3	12	0,900	43477	25	24	8	3,279	5602	100	18	7,981
6x80					2604	4	10A	1,778	43643	20	24	8	3,279	5604	100	9	13,088
8x30					26052	3	10	1,353									
8x40					26053	3	10	1,353	43644	15	80	10	3,279	56053	100	18	9,036
8x50					2606	3	10	1,353	43645	12	80	10	3,279	5606	100	9	19,644
8x60	41659	2	10	0,730	2608	4	10	1,353	43478	10	80	10	3,279	5608	100	9	13,898
8x70					2609	3	10A	2,533	43646	10	80	10	3,279	5609	100	9	25,476
8x80					2610	3	10A	2,533	43479	8	80	10	3,279	5610	100	9	17,201
8x90					26100	2	10A	2,533	43647	8	20	10	3,279	56100	100	9	31,300
8x100					2612	2	10A	2,533	43648	8	20	10	3,279	5612	75	9	28,566
10x80					26134	2	10A	2,533	43651	6	20	10	3,279	56134	60	9	30,377
10x90					26135	2	10A	2,533	43652	6	20	10	3,279	56135	50	9	16,288
10x100					26136	2	10A	2,533	43653	6	20	10	3,279	56136	45	9	27,257

**CONJUNTO DE ENSAMBLAJE**

VIS D'ASSEMBLAGE ALLEN  
ASSEMBLY SCREW ALLEN



M6x40 Allen					26203	1	12	1,778									
-------------	--	--	--	--	-------	---	----	-------	--	--	--	--	--	--	--	--	--

**CONJUNTO DE ENSAMBLAJE**

VIS D'ASSEMBLAG / ASSEMBLY SCREW



M6x35 Caceza Ancha					26206	1	10	1,778									
--------------------	--	--	--	--	-------	---	----	-------	--	--	--	--	--	--	--	--	--

**EMBELLECEDOR**

CACHE VIS / COVER



7 Marrón					26212	10	12	0,900									
7 Blanco					2622	10	12	0,900									
5 Negro					26221	15	12	0,900									
5 Beige					26223	15	12	0,900									

- BEIGE | BEIGE | BEIGE
- BLANCO | BLANC | WHITE
- MARRÓN | MARRON | BROWN

- NEGRO | NOIR | BLACK
- CABEZA ANCHA | TÊTE LARGE | LARGE HEAD



MEDIDA: DIMENSION / SIZE | Nº PIEZAS: Nº PCS / Nº PCS | UDS. EMBALAJE: U.C. / PACKING | PRECIO TARIFA: PRX / PRICE

MEDIDA	BOLSA SACHET BAG				PEQUEÑOS TRABAJOS BRICOLAGE D.I.Y.				CAJA PROFESIONAL PLÁSTICO BOÎTE PROFESSIONNELLE PROFESSIONAL BOX				CAJA PROFESIONAL CARTÓN BOÎTE PROFESSIONNELLE CARTON PROFESSIONAL CARTON BOX			
	REF.	Nº PIEZAS	UDS. EMBALAJE	PRECIO TARIFA	REF.	Nº PIEZAS	UDS. EMBALAJE	PRECIO TARIFA	REF.	Nº PIEZAS	UDS. EMBALAJE	UDS. PEDIDO	PRECIO TARIFA	REF.	Nº PIEZAS	UDS. EMBALAJE

**TORNILLO DE ENSAMBLAR**

PAVONADO  
VIS D'ASSEMBLAGE POUR CLÉ ACIER NOIR  
CONNECTING SCREW BLACK ZINC PLATED



5x40					26239	6	12	0,900						56239	400	9	38,166
5x50	41660	6	10	0,730	2624	6	12	0,900	43505	40	48	12	3,279	5624	300	9	18,027
7x40					26241	6	12	0,900						56241	300	9	35,388
7x50	41662	6	10	0,730	26242	6	12	0,900	43506	25	48	12	3,279	56242	200	9	44,236

**TORNILLO DE ENSAMBLAR**

ZINCADO  
VIS D'ASSEMBLAGE POUR CLÉ ACIER ZINGUÉ  
CONNECTING SCREW ZINC PLATED



5x40					26243	6	12	0,900						56243	400	9	38,166
5x50	41661	6	10	0,730	26244	6	12	0,900	43509	40	48	12	3,279	56244	300	9	21,958
7x40					26245	6	12	0,900						56245	300	9	32,000
7x50					26246	6	12	0,900	43510	25	48	12	3,279	56246	200	9	33,492

**TORNILLO DE ENSAMBLAR CON LLAVE**

ZINCADO  
VIS D'ASSEMBLAGE AVEC CLÉ ACIER ZINGUÉ  
CONNECTING SCREW WITH KEY ZINC PLATED



5x50					2625	4	12	0,900									
7x50					26252	4	12	0,900									

**TORNILLO CON TUERCA DE UNIÓN**

VIS D'ASSEMBLAGE POUR MEUBLE  
FURNITURE ASSEMBLY SCREW



Metálico L35					26467	1	10	3,333									
Metálico L40					26468	1	10	3,333									
Metálico L60					26470	1	10	3,333									
Marrón 28-34					2647	4	10	1,778									
Blanco 28-34					26472	4	10	1,778									
Roble 28-34					26474	4	10	1,778									
Marrón 34-40					26476	4	10	1,778									
Blanco 34-40					26478	4	10	1,778									
Roble 34-40					2648	4	10	1,778									
Marrón 37-43					26483	2	10	1,353									
Blanco 37-43					26484	2	10	1,353									

**ESPIGA DE ENSAMBLAJE**

TOURILLON / ASSEMBLY DOWEL



Marrón					2672	6	12	0,900									
--------	--	--	--	--	------	---	----	-------	--	--	--	--	--	--	--	--	--

**CLAVIJA MADERA**

TOURILLON D'ASSEMBLAGE BOIS  
WOOD ASSEMBLY PIN



6 mm					26725	15	12	0,900	43512	60	24	8	3,279				
8 mm					26726	10	10	0,900	43513	50	24	8	3,279				
10 mm					26727	7	10	0,900	43514	30	24	8	3,279				

- BLANCO | BLANC | WHITE
- MARRÓN | MARRON | BROWN
- METÁLICO | MÉTALLIQUE | METALLIC
- ROBLE | CHÊNE | OAK



MEDIDA: DIMENSION / SIZE | Nº PIEZAS: Nº PCS / Nº PCS | UDS. EMBALAJE: U.C. / PACKING | PRECIO TARIFA: PRIX / PRICE

MEDIDA	BOLSA SACHET BAG				PEQUEÑOS TRABAJOS BRICOLAGE D.I.Y.				CAJA PROFESIONAL PLÁSTICO BOÎTE PROFESSIONNELLE PROFESSIONAL BOX				CAJA PROFESIONAL CARTÓN BOÎTE PROFESSIONNELLE CARTON PROFESSIONAL CARTON BOX			
	REF.	Nº PIEZAS	UDS. EMBALAJE	PRECIO TARIFA	REF.	Nº PIEZAS	UDS. EMBALAJE	PRECIO TARIFA	REF.	Nº PIEZAS	UDS. EMBALAJE	UDS. PEDIDO	PRECIO TARIFA	REF.	Nº PIEZAS	UDS. EMBALAJE

**OVALILLOS**

CUVETTES / RAISED SCREW WASHERS



11 mm Niquelado	41670	60	10	1,569	2630	60	12	1,778						5630	1000	54	16,204
11 mm Latonado	41671	60	10	1,569	2632	60	12	1,778	43654	100	160	10	3,279	5632	1000	54	21,937
13 mm Niquelado					2631	50	12	1,778						5631	1000	27	17,668
13 mm Latonado					2633	50	12	1,778	43655	100	160	10	3,279	5633	1000	27	21,937

**SOPORTE ESTANTE**

TAQUET PLASTIQUE / SHELF SUPPORT



Blanco					2638	4	12	0,900	43656	30	160	10	3,279				
Marrón					26381	4	12	0,900	43657	30	160	10	3,279				

**SOPORTE ESTANTE GRANDE**

TAQUET PLASTIQUE GRAND / LARGE SHELF SUPPORT



Blanco					26382	2	12	0,900	43658	20	48	12	3,279				
Marrón					26383	2	12	0,900	43659	20	48	12	3,279				

**TOPE DOS PUNTAS**

TAQUET À POINTE  
SHOWCASE  
SUPPORT TWO  
POINTS



Pequeño Blanco					26443	6	12	0,900									
Pequeño Marrón					26444	6	12	0,900									
Grande Blanco					26445	6	12	0,900									
Grande Marrón					26446	6	12	0,900									

**TAPA DECORATIVA**

TAQUET À PRESSION / CLEAT



Marrón 10 mm					2642	8	12	0,900									
Blanco 10 mm					26422	8	12	0,900									
Roble 10 mm					26424	8	12	0,900									
Marrón 8 mm					26426	8	12	0,900									
Blanco 8 mm	41669	8	10	0,730	26427	8	12	0,900									

**TAPA TORNILLOS  
DIAMETRO 12**

CACHE VIS Ø12 mm / SCREW COVER Ø12 mm



Sapeli	45723	40	20	1,625													
Roble	45724	40	20	1,625													
Blanco	45727	40	20	1,625													
Gris	45728	40	20	1,625													
Pino	45729	40	20	1,625													
Haya	45730	40	20	1,625													
Nogal	45731	40	20	1,625													
Cerezo	45732	40	20	1,625													
Wengué	45733	40	20	1,625													

- BLANCO | BLANC | WHITE
- CEREZO | CERISIER | CHERRY

- GRANDE BLANCO | GRAND BLANC | LARGE WHITE
- GRANDE MARRÓN | GRAND MARRON | LARGE BROWN

- GRIS | GRIS | GREY

- HAYA | HÊTRE | BEECH
- LATONADO | LAITONNÉ | BRASS PLATED
- MARRÓN | MARRON | BROWN

- NIQUELADO | NICKELÉ | NICKEL-PLATED

- NOGAL | NOYER | WALNUT
- PEQUEÑO BLANCO | PETIT BLANC | SMALL WHITE
- PEQUEÑO MARRÓN | PETIT MARRON | SMALL BROWN

- PINO | PIN | PINE

- ROBLE | CHÊNE | OAK
- SAPELI | SAPELLI | SAPELY
- WENGUÉ | WENGUÉ | WENGUÉ



MEDIDA: DIMENSION / SIZE | Nº PIEZAS: Nº PCS / Nº PCS | UDS. EMBALAJE: U.C. / PACKING | PRECIO TARIFA: PRIX / PRICE

MEDIDA	BOLSA SACHET BAG				PEQUEÑOS TRABAJOS BRICOLAGE D.I.Y.				CAJA PROFESIONAL PLÁSTICO BOÎTE PROFESSIONNELLE PROFESSIONAL BOX				CAJA PROFESIONAL CARTÓN BOÎTE PROFESSIONNELLE CARTON PROFESSIONAL CARTON BOX					
	REF.	Nº PIEZAS	UDS. EMBALAJE	PRECIO TARIFA	REF.	Nº PIEZAS	UDS. EMBALAJE	PRECIO TARIFA	REF.	Nº PIEZAS	UDS. EMBALAJE	UDS. PEDIDO	PRECIO TARIFA	REF.	Nº PIEZAS	UDS. EMBALAJE	PRECIO TARIFA	
<b>TORNILLO</b> <b>CABEZA PLANA</b> ZINCADO VIS MÉTAUX TÊTE FRAISÉE FENDUE ACIER ZINGUÉ SLOTTED FLAT HEAD METAL SCREW ZINC PLATED	M3x10	4942	40	10	0,730	2700	40	12	0,900					5700	500	54	4,306	
	M3x16					27001	35	12	0,900					57001	500	54	4,472	
	M3x20	4943	30	10	0,730	2701	30	12	0,900					5701	500	27	6,799	
	M3x30					2702	15	12	0,900					5702	500	18	20,753	
	M4x20	4944	16	10	0,730	2703	16	12	0,900					5703	500	18	7,905	
	M4x25					27031	14	12	0,900					57031	500	18	18,553	
	M4x30	4945	9	10	0,730	2704	11	12	0,900					5704	500	18	9,941	
	M4x35					27045	10	12	0,900									
	M4x40	4946	10	10	0,730	2705	10	12	0,900					5705	500	9	17,117	
	M5x20	41498	12	10	0,730	2706	15	12	0,900					5706	500	18	10,627	
	M5x30	41672	7	10	0,730	2707	9	12	0,900					5707	500	9	14,850	
	M5x35					27075	7	12	0,900									
	M5x40					2708	5	12	0,900					5708	500	9	37,112	
	M5x50					2709	5	12	0,900					5709	200	9	11,330	
	M6x20					2710	10	12	0,900					5710	200	27	16,638	
	M6x25					27105	8	12	0,900									
	M6x30					2711	6	12	0,900					5711	200	18	8,899	
	M6x35					27115	5	12	0,900									
	M6x40					2712	5	12	0,900					5712	200	9	26,380	
	M6x50	41673	5	10	0,730	2713	4	12	0,900					5713	200	9	33,772	
M6x60					2714	4	12	0,900					5714	200	9	34,316		
<b>TORNILLO</b> <b>CABEZA REDONDA</b> ZINCADO VIS MÉTAUX TÊTE RONDE FENDUE ACIER ZINGUÉ SLOTTED ROUND HEAD METAL SCREW ZINC PLATED	M3x20					28296	12	12	0,900									
	M4x20					28298	8	12	0,900									
	M4x30					28299	8	12	0,900									
	M5x30					28300	5	12	0,900									
<b>TORNILLO</b> <b>CABEZA CILÍNDRICA</b> ZINCADO VIS MÉTAUX TÊTE CYLINDRIQUE FENDUE ACIER ZINGUÉ SLOTTED PAN HEAD METAL SCREW ZINC PLATED	M3x10					2720	32	12	0,900					5720	500	54	5,406	
	M3x20					2721	25	12	0,900					5721	500	27	11,225	
	M3x30					2722	12	12	0,900					5722	500	18	27,173	
	M4x16					27227	16	12	0,900									
	M4x20	4947	14	10	0,730	2723	14	12	0,900					5723	500	18	10,467	
	M4x25					27235	12	12	0,900									
	M4x30	4948	10	10	0,730	2724	10	12	0,900					5724	500	9	13,430	
	M4x40	4949	6	10	0,730	27241	6	12	0,900					57241	500	9	46,452	
	M5x20	41499	10	10	0,730	27243	10	12	0,900					57243	500	9	24,812	
	M5x25					27244	8	12	0,900									
	M5x30					27245	6	12	0,900					57245	500	9	18,826	
	M5x40					27247	6	12	0,900					57247	500	9	31,572	
	M5x50	41674	6	10	0,730	27248	6	12	0,900					57248	200	9	31,996	
	M6x20					2725	6	12	0,900					5725	200	18	10,761	
	M6x30					2726	6	12	0,900					5726	200	18	21,629	
	M6x40					2727	6	12	0,900					5727	200	9	15,408	
M6x50	41675	5	10	0,730	2728	4	12	0,900					5728	200	9	37,652		
M6x60	41676	4	10	0,730	2729	4	12	0,900					5729	200	9	36,628		
<b>TORNILLO</b> <b>CABEZA CILÍNDRICA</b> LATÓN VIS MÉTAUX TÊTE CYLINDRIQUE FENDUE LAITON SLOTTED PAN HEAD METAL SCREW SOLID BRASS	M4x16					27295	5	12	1,778									
	M4x20					27296	4	12	1,778									
	M4x30					27297	3	12	1,778									
	M5x20					27298	2	12	1,778									
	M6x30					27299	2	12	1,778									
M6x40					27300	2	12	1,778										



MEDIDA: DIMENSION / SIZE | Nº PIEZAS: Nº PCS / Nº PCS | UDS. EMBALAJE: U.C. / PACKING | PRECIO TARIFA: PRIX / PRICE

MEDIDA	BOLSA SACHET BAG				PEQUEÑOS TRABAJOS BRICOLAGE D.I.Y.				CAJA PROFESIONAL PLÁSTICO BOÎTE PROFESSIONNELLE PROFESSIONAL BOX					CAJA PROFESIONAL CARTÓN BOÎTE PROFESSIONNELLE CARTON PROFESSIONAL CARTON BOX			
	REF.	Nº PIEZAS	UDS. EMBALAJE	PRECIO TARIFA	REF.	Nº PIEZAS	UDS. EMBALAJE	PRECIO TARIFA	REF.	Nº PIEZAS	UDS. EMBALAJE	UDS. PEDIDO	PRECIO TARIFA	REF.	Nº PIEZAS	UDS. EMBALAJE	PRECIO TARIFA

**TORNILLO**

**CABEZA HEXAGONAL**

**ZINCADO**

VIS MÉTAUX TÊTE HEXAGONALE ACIER ZINGUÉ  
HEXAGONAL HEAD METAL SCREW ZINC PLATED



M4x20					27349	10	12	0,900						57349	500	18	12,687
M4x30					27348	8	12	0,900									
M4x40					27350	6	12	0,900									
M5x16					27351	12	12	0,900									
M5x20	4952	8	10	0,730	2735	8	12	0,900						5735	500	18	16,791
M5x25					27352	8	12	0,900									
M5x30	4953	8	10	0,730	2736	8	12	0,900						5736	500	9	17,694
M5x40					2737	6	12	0,900						5737	500	9	57,572
M5x50					2738	6	12	0,900						5738	200	9	30,012
M5x60					27380	4	12	0,900									
M6x16					27399	8	12	0,900									
M6x20	4950	8	10	0,730	2740	8	12	0,900						5740	500	9	19,528
M6x30	4951	7	10	0,730	2742	7	12	0,900									
M6x35					27429	6	12	0,900									
M6x40	41500	6	10	0,730	2743	6	12	0,900						5743	200	9	12,588
M6x50	41501	5	10	0,730	2744	6	12	0,900						5744	200	9	14,705
M6x60					27442	5	10	0,900						57442	200	9	33,700
M8x15														5745	200	18	23,808
M8x20					2745	3	10	0,900						57451	200	18	26,309
M8x30					2746	3	10	0,900						5746	200	9	14,468
M8x40					2747	3	10	0,900						5747	100	9	9,354
M8x50					2748	3	10	0,900						5748	100	9	14,268
M8x60					2749	2	10	0,900						5749	100	9	16,136
M8x70					2750	1	10A	1,778									
M8x90					2751	1	10A	1,778									
M8x100					27515	1	10A	1,778									
M10x20					27537	3	10	1,778									
M10x30					27538	3	10	1,778									
M10x40					27539	3	10	1,778									
M10x80					2756	1	10A	1,778						5756	50	9	32,612
M10x90					2757	1	10A	1,778						5757	45	9	35,484
M10x100					2758	1	10A	1,778						5758	40	9	34,400

**TORNILLO**

**CABEZA HEXAGONAL**

**ZINCADO DIN 931**

VIS MÉTAUX TÊTE HEXAGONALE ACIER ZINGUÉ  
HEXAGONAL HEAD METAL SCREW ZINC PLATED



M6x60					27730	5	10	1,778									
M6x80					27731	2	10	1,778									
M6x100					27732	1	10	1,778									
M8x40					27733	3	10	1,778									
M8x50					27734	3	10	1,778									
M8x80					27735	1	10	1,778									
M8x100					27736	1	10	1,778									

**TORNILLO**

**CABEZA ALOMADA**

**ZINCADO**

VIS MÉTAUX TÊTE BOMBÉ ACIER ZINGUÉ  
PAN HEAD METAL SCREW ZINC PLATED



M3x10									43936	150	80	10	3,279				
M4x20									43937	80	80	10	3,279				
M4x40									43938	40	80	10	3,279				



MEDIDA: DIMENSION / SIZE | Nº PIEZAS: Nº PCS / Nº PCS | UDS. EMBALAJE: U.C. / PACKING | PRECIO TARIFA: PRIX / PRICE

MEDIDA	BOLSA SACHET BAG				PEQUEÑOS TRABAJOS BRICOLAGE D.I.Y.				CAJA PROFESIONAL PLÁSTICO BOÎTE PROFESSIONNELLE PROFESSIONAL BOX					CAJA PROFESIONAL CARTÓN BOÎTE PROFESSIONNELLE CARTON PROFESSIONAL CARTON BOX			
	REF.	Nº PIEZAS	UDS. EMBALAJE	PRECIO TARIFA	REF.	Nº PIEZAS	UDS. EMBALAJE	PRECIO TARIFA	REF.	Nº PIEZAS	UDS. EMBALAJE	UDS. PEDIDO	PRECIO TARIFA	REF.	Nº PIEZAS	UDS. EMBALAJE	PRECIO TARIFA

**TORNILLO AUTOTALADRANTE**  
**CABEZA ALOMADA**  
**ZINCADO**

VIS TÔLE AUTOPERCEUSE TÊTE CYLINDRIQUE BOMBÉE PHILLIPS ACIER ZINGUÉ  
SELF-DRILLING PHILLIPS PAN HEAD SCREW ZINC PLATED



2,90x13	41682	22	10	0,730	2774	18	12	0,900						5774	500	54	21,052
3,50x9,5					27743	15	12	0,900	43662	200	80	10	3,279	57743	500	54	6,261
3,50x13					27744	15	12	0,900	43663	180	80	10	3,279	57744	500	54	7,564
3,50x16	41683	20	10	0,730	27740	15	12	0,900	43664	140	80	10	3,279	57740	500	27	7,844
3,50x19					27745	14	12	0,900						57745	500	27	8,519
3,90x19	41684	15	10	0,730	27741	12	12	0,900						57741	500	27	17,715
4,20x13					27746	12	12	0,900	43665	120	80	10	3,279	57746	500	27	8,723
4,20x16					27747	10	12	0,900	43666	110	80	10	3,279	57747	500	27	9,289
4,20x19					27748	10	12	0,900	43667	90	80	10	3,279	57748	500	27	12,163
4,20x25					27749	8	12	0,900	43668	70	80	10	3,279	57749	500	18	14,847
4,20x32					2775	7	12	0,900	43669	50	80	10	3,279	5775	500	9	33,252
4,20x38					27750	6	12	0,900						57750	500	9	23,172
4,80x13														57751	500	27	27,645
4,80x16					27752	9	12	0,900						57752	500	18	24,573
4,80x19					27753	8	12	0,900						57753	500	18	13,943
4,80x25	41685	10	10	0,730	27742	7	12	0,900						57742	500	9	16,452
4,80x32					27754	6	12	0,900	43670	45	80	10	3,279	57754	500	9	22,306
4,80x38					27755	5	12	0,900	43671	40	80	10	3,279	57755	500	9	34,332
4,80x45					27756	4	12	0,900	43672	30	80	10	3,279	57756	400	9	38,580
4,80x50					27757	4	12	0,900	43673	25	80	10	3,279	57757	350	9	40,016
4,80x63					27758	4	12	0,900						57758	300	9	41,115
5,50x63					27759	3	12	0,900	43674	20	80	10	3,279	57759	250	9	41,114
5,50x73					2776	2	10	0,900	43675	18	80	10	3,279	5776	180	9	37,594

**TORNILLO AUTOTALADRANTE**  
**CABEZA PLANA**  
**ZINCADO**

VIS TÔLE AUTOPERCEUSE TÊTE FRAISÉE PHILLIPS ACIER ZINGUÉ  
SELF-DRILLING PHILLIPS COUNTERSUNK HEAD SCREW ZINC PLATED



3,50x9,5					27760	15	12	0,900	43676	200	80	10	3,279	57760	500	54	14,972
3,50x13					27761	15	12	0,900	43677	180	80	10	3,279	57761	500	54	7,218
3,50x16					27762	15	12	0,900	43678	140	80	10	3,279	57762	500	27	8,105
3,50x19					27763	14	12	0,900						57763	500	27	13,865
4,20x13					27764	12	12	0,900	43679	120	80	10	3,279	57764	500	27	11,965
4,20x16					27765	10	12	0,900	43680	110	80	10	3,279	57765	500	27	16,481
4,20x19					27766	10	12	0,900	43681	90	80	10	3,279	57766	500	27	10,763
4,20x25					27767	8	12	0,900	43682	70	80	10	3,279	57767	500	18	13,769
4,20x32					27768	7	12	0,900	43683	50	80	10	3,279	57768	500	9	14,305
4,20x38					27769	6	12	0,900						57769	500	9	31,412
4,80x16					2777	9	12	0,900						5777	500	18	21,893
4,80x19					27770	8	12	0,900						57770	500	18	23,523
4,80x25					27771	7	12	0,900						57771	500	9	29,552
4,80x32					27772	6	12	0,900	43684	45	80	10	3,279	57772	500	9	34,366
4,80x38					27773	5	12	0,900	43685	40	80	10	3,279	57773	500	9	45,612
4,80x45					27774	4	12	0,900	43686	30	80	10	3,279	57774	400	9	38,116

**TORNILLO AUTOTALADRANTE**  
**CABEZA HEXAGONAL**  
**ZINCADO**

VIS TÔLE AUTOPERCEUSE TÊTE HEXAGONALE ACIER ZINGUÉ  
SELF-DRILLING HEXAGONAL HEAD SCREW ZINC PLATED



3,50x13					27775	12	12	0,900	43687	110	80	10	3,279	57775	500	27	13,399
3,50x16					27776	10	12	0,900	43688	100	80	10	3,279	57776	500	27	16,505
4,20x13					27777	10	12	0,900	43689	90	80	10	3,279	57777	500	27	11,058
4,20x16					27778	8	12	0,900	43690	80	80	10	3,279	57778	500	27	11,958
4,20x19					27779	8	12	0,900	43691	70	80	10	3,279	57779	500	18	13,018



MEDIDA: DIMENSION / SIZE | Nº PIEZAS: Nº PCS / Nº PCS | UDS. EMBALAJE: U.C. / PACKING | PRECIO TARIFA: PRIX / PRICE

MEDIDA	BOLSA SACHET BAG				PEQUEÑOS TRABAJOS BRICOLAGE D.I.Y.				CAJA PROFESIONAL PLÁSTICO BOÎTE PROFESSIONNELLE PROFESSIONAL BOX				CAJA PROFESIONAL CARTÓN BOÎTE PROFESSIONNELLE CARTON PROFESSIONAL CARTON BOX				
	REF.	Nº PIEZAS	UDS. EMBALAJE	PRECIO TARIFA	REF.	Nº PIEZAS	UDS. EMBALAJE	PRECIO TARIFA	REF.	Nº PIEZAS	UDS. EMBALAJE	UDS. PEDIDO	PRECIO TARIFA	REF.	Nº PIEZAS	UDS. EMBALAJE	PRECIO TARIFA
<b>TORNILLO AUTOTALADRANTE</b> <b>CABEZA HEXAGONAL</b> ZINCADO MONTADO CON ARANDELA EPDM VIS TÔLE AUTOPERCEUSE TÊTE HEXAGONALE À EMBASE ACIER ZINGUÉ SELF-DRILLING HEXAGONAL HEAD SCREW WITH COLLAR ZINC PLATED	Ø16 - 4,80x16				2778	8	10	1,353	43692	26	80	10	3,279	5778	450	9	26,796
	Ø16 - 4,80x19				27780	8	10	1,353	43693	22	80	10	3,279	57780	400	9	24,588
	Ø16 - 4,80x25				27781	7	10	1,353	43694	20	80	10	3,279	57781	350	9	23,271
	Ø19 - 5,50x22				27782	6	10	1,353	43695	16	80	10	3,279	57782	280	9	22,589
	Ø19 - 5,50x25				27783	6	10	1,353						57783	250	9	20,986
	Ø19 - 5,50x32				27784	5	10	1,353						57784	220	9	20,712
	Ø19 - 6,30x25				27785	5	10	1,353	43696	12	80	10	3,279	57785	220	9	27,770
	Ø19 - 6,30x32				27786	4	10	1,353	43697	10	80	10	3,279	57786	200	9	27,471
	Ø19 - 6,30x38				27787	4	10	1,353						57787	180	9	24,243

**TORNILLO ROSCA CHAPA**

**CABEZA ALOMADA**

ZINCADO  
 VIS TÔLE TÊTE CYLINDRIQUE BOMBÉE ACIER ZINGUÉ  
 PHILLIPS PAN HEAD SELF TAPPING SCREW ZINC PLATED



2,90x6,5					2820	25	12	0,900	43580	300	80	10	3,279	5819	800	54	18,064
2,90x9,5	4954	25	10	0,730	28204	22	12	0,900						5820	500	54	5,270
2,90x13	4955	22	10	0,730	28205	21	12	0,900						58204	500	54	9,304
2,90x16	4956	21	10	0,730	28206	20	12	0,900						58205	500	54	16,072
2,90x19					28207	19	12	0,900									
3,25x25					28217	16	12	0,900									
3,50x9,5					28209	20	12	0,900						58209	500	54	9,842
3,50x13	4957	20	10	0,730	2821	20	12	0,900	43581	200	80	10	3,279	5821	500	54	7,038
3,50x16					28213	20	12	0,900						58213	500	27	11,025
3,50x19	4958	20	10	0,730	28215	20	12	0,900						58215	500	27	17,285
3,50x22	4959	18	10	0,730	28216	18	12	0,900						58216	500	27	13,345
3,90x9,5					28219	18	12	0,900						58219	500	54	9,798
3,90x13	4960	16	10	0,730	2822	16	12	0,900	43582	150	80	10	3,279	5822	500	27	8,631
3,90x16					28225	15	12	0,900	43583	125	80	10	3,279	58225	500	27	9,347
3,90x19	4961	15	10	0,730	28232	15	12	0,900	43584	125	80	10	3,279	58232	500	18	10,673
3,90x25	4962	15	10	0,730	28235	15	12	0,900						58235	500	18	12,531
4,20x13	4963	20	10	0,730	2824	20	12	0,900	43585	120	80	10	3,279	5824	500	27	10,053
4,20x16					28241	20	12	0,900						58241	500	27	17,625
4,20x19	4964	15	10	0,730	28245	15	12	0,900	43586	100	80	10	3,279	58245	500	18	12,003
4,20x22					28247	14	12	0,900									
4,20x25	4965	12	10	0,730	2825	12	12	0,900	43587	80	80	10	3,279	5825	500	18	14,321
4,20x32	4966	10	10	0,730	28251	10	12	0,900						58251	500	9	24,732
4,20x38					28252	8	12	0,900						58252	500	9	29,922
4,80x13	4967	20	10	0,730	28253	20	12	0,900						58253	500	18	13,146
4,80x16					28254	15	12	0,900						58254	500	18	20,517
4,80x19	41502	15	10	0,730	28256	15	12	0,900						58256	500	18	16,269
4,80x25	4968	9	10	0,730	2826	9	12	0,900	43588	70	48	12	3,279	5826	500	18	18,745
4,80x32	4969	8	10	0,730	28263	8	12	0,900	43589	50	48	12	3,279	58263	500	9	21,754
4,80x38					28264	7	12	0,900						58264	500	9	24,792
4,80x50					28265	5	12	0,900						58265	350	9	50,070
5,50x19	4970	12	10	0,730	28266	12	12	0,900						58266	500	9	19,191
5,50x25	4971	6	10	0,730	2827	6	12	0,900	43590	50	48	12	3,279	5827	500	9	26,274
5,50x32					28270	5	12	0,900						58270	400	9	38,356
5,50x38					28271	5	12	0,900						58271	400	9	39,348
5,50x50					28272	4	12	0,900									





MEDIDA: DIMENSION / SIZE | Nº PIEZAS: Nº PCS / Nº PCS | UDS. EMBALAJE: U.C. / PACKING | PRECIO TARIFA: PRIX / PRICE

MEDIDA	BOLSA SACHET BAG				PEQUEÑOS TRABAJOS BRICOLAGE D.I.Y.				CAJA PROFESIONAL PLÁSTICO BOÎTE PROFESSIONNELLE PROFESSIONAL BOX					CAJA PROFESIONAL CARTÓN BOÎTE PROFESSIONNELLE CARTON PROFESSIONAL CARTON BOX			
	REF.	Nº PIEZAS	UDS. EMBALAJE	PRECIO TARIFA	REF.	Nº PIEZAS	UDS. EMBALAJE	PRECIO TARIFA	REF.	Nº PIEZAS	UDS. EMBALAJE	UDS. PEDIDO	PRECIO TARIFA	REF.	Nº PIEZAS	UDS. EMBALAJE	PRECIO TARIFA
<b>TORNILLO ROSCA CHAPA</b> <b>CABEZA PLANA</b> ZINCADO VIS TÔLE TÊTE PLATE ACIER ZINGUÉ COUNTERSUNK HEAD SELF TAPPING SCREW ZINC PLATED	2,90x13				28186	22	12	0,900									
	2,90x16				28187	21	12	0,900									
	2,90x19				28188	20	12	0,900									
	3,50x13				28189	20	12	0,900									
	3,50x19				28190	20	12	0,900									
<b>TORNILLO ROSCA CHAPA</b> <b>CABEZA GOTA SEBO</b> ZINCADO VIS TÔLE TÊTE BOMBÉÉ ACIER ZINGUÉ OVAL HEAD SELF TAPPING SCREW ZINC PLATED	2,90x13				28170	22	12	0,900									
	2,90x16				28171	21	12	0,900									
	3,50x13				28172	20	12	0,900									
	3,50x16				28173	20	12	0,900									
	3,50x19				28174	20	12	0,900									
	3,50x25				28175	16	12	0,900									
	4,20x13				28176	20	12	0,900									
	4,20x16				28177	20	12	0,900									
	4,20x19				28178	15	12	0,900									
	4,20x25				28179	12	12	0,900									
	4,80x13				28180	20	12	0,900									
	4,80x16				28181	15	12	0,900									
	4,80x19				28182	15	12	0,900									
	4,80x25				28183	9	12	0,900									
	4,80x32				28184	8	12	0,900									
5,50x25				28185	6	12	0,900										
<b>REMACHE DE ALUMINIO</b> RIVET D'ALUMINIUM / ALUMINIUM RIVETS	3x7				2828	30	10	1,353	43717	90	80	10	3,279				
	3,20x10				28282	25	10	1,353	43515	90	80	10	3,279				
	3,20x12				28280	25	10	1,353	43718	80	80	10	3,279				
	4x8				28281	20	10	1,353	43719	70	80	10	3,279				
	4x10				28283	20	10	1,353	43720	60	80	10	3,279				
	4x12				28285	20	10	1,353	43516	60	80	10	3,279				
	4x16				28284	17	10	1,353	43721	50	80	10	3,279				
	4,80x10				28286	15	10	1,353	43722	45	80	10	3,279				
	4,80x12				28287	15	10	1,353	43723	40	80	10	3,279				
	4,80x16				28289	15	10	1,778	43517	40	80	10	3,279				
	4,80x18				28290	12	10	1,778	43724	35	80	10	3,279				
	5x15				28288	15	10	1,778	43725	35	80	10	3,279				
	<b>TORNILLO TIRADOR</b> ZINCADO VIS POËLIER ACIER ZINGUÉ DOUBLE SLOTTED TRUSS HEAD MACHINE SCREW ZINC PLATED	M4x20				28306	20	10	1,353	43600	100	48	12	3,279	58306	500	18
M4x25					28317	18	10	1,353						58317	500	18	32,253
M4x30					28307	18	10	1,353	43601	70	48	12	3,279	58307	500	9	11,940
M4x35					28318	15	10	1,353						58318	500	9	22,352
M4x40					28308	15	10	1,353	43602	40	80	10	3,279	58308	500	9	28,332
M4x45					28319	10	10	1,353						58319	400	9	37,284
M4x50					28320	8	10	1,353						58320	350	9	11,896
M6x60				28314	4	10	1,353						58314	150	9	21,396	
<b>TORNILLO DE CORTAR</b> VIS À DÉCOUPER / CUTTING SCREW					26679	4	12	1,778	43511	10	160	10	3,279				



MEDIDA: DIMENSION / SIZE | Nº PIEZAS: Nº PCS / Nº PCS | UDS. EMBALAJE: U.C. / PACKING | PRECIO TARIFA: PRIX / PRICE

MEDIDA	BOLSA SACHET BAG				PEQUEÑOS TRABAJOS BRICOLAGE D.I.Y.				CAJA PROFESIONAL PLÁSTICO BOÎTE PROFESSIONNELLE PROFESSIONAL BOX					CAJA PROFESIONAL CARTÓN BOÎTE PROFESSIONNELLE CARTON PROFESSIONAL CARTON BOX			
	REF.	Nº PIEZAS	UDS. EMBALAJE	PRECIO TARIFA	REF.	Nº PIEZAS	UDS. EMBALAJE	PRECIO TARIFA	REF.	Nº PIEZAS	UDS. EMBALAJE	UDS. PEDIDO	PRECIO TARIFA	REF.	Nº PIEZAS	UDS. EMBALAJE	PRECIO TARIFA

**TORNILLO**

**CABEZA REDONDA  
CUELLO CUADRADO**

ZINCADO  
VIS MÉTAUX TÊTE RONDE COLLET CARRÉ  
ACIER ZINGUÉ  
MUSHROOM HEAD SQUARE NECK BOLT  
ZINC PLATED



M5x20					28321	4	12	0,900						5831	200	18	25,261
M5x30	41677	4	10	0,730	2831	4	10	0,900						5832	200	9	33,460
M5x40					2832	4	10	0,900						5833	200	9	20,476
M5x50														5834	200	9	34,412
M5x60														58341	200	18	29,424
M6x15																	
M6x20					28342	3	10	0,900									
M6x30														58343	200	18	38,573
M6x40					28345	2	10	0,900						58345	200	9	28,636
M6x50	41678	2	10	0,730	28357	2	10	0,900						58357	200	9	47,404
M6x60														58359	175	9	45,742
M8x40														5836	100	9	25,712
M8x50														58363	100	9	29,460
M8x70														58366	75	9	28,212
M8x80														58367	75	9	30,244
M8x90														58368	50	9	34,044
M8x110														58369	50	9	33,832

**TUERCA HEXAGONAL**

ZINCADO  
ÉCROU HEXAGONAL ACIER ZINGUÉ  
HEXAGONAL NUT ZINC PLATED



M3	4972	70	10	0,730	2837	70	12	0,900	43755	800	48	12	3,279	5837	1000	54	4,588
M4	4973	48	10	0,730	2838	48	12	0,900	43756	400	48	12	3,279	5838	1000	27	6,865
M5	4974	30	10	0,730	2839	30	12	0,900	43757	200	48	12	3,279	5839	1000	27	9,297
M6	4975	18	10	0,730	2840	18	12	0,900	43758	150	24	8	3,279	5840	1000	18	14,093
M7					2841	12	12	0,900						5841	500	18	22,013
M8	4976	9	10	0,730	2842	9	12	0,900	43759	90	24	8	3,279	5842	400	18	12,100
M10	41503	7	10	0,730	2844	7	12	0,900	43760	45	24	8	3,279	5844	200	18	13,256
M12					28443	3	12	0,900	43761	30	24	8	3,279	58443	120	18	21,602

**TUERCA EMPOTRABLE**

ZINCADO  
ÉCROU À FRAPPER  
ACIER ZINGUÉ  
TEE NUT ZINC  
PLATED



M6					28448	2	12	0,900									
----	--	--	--	--	-------	---	----	-------	--	--	--	--	--	--	--	--	--

**TUERCA AUTOBLOCANTE**

ZINCADO  
ÉCROU  
INDESSERRABLE  
ACIER ZINGUÉ  
SELF LOCKING NUT  
ZINC PLATED



M3					28455	14	12	0,900						5845	1000	27	23,165
M4					2845	12	12	0,900						58450	1000	27	25,445
M5					28450	10	12	0,900						58451	800	18	16,042
M6	41686	15	10	0,730	28451	6	12	0,900						58452	700	9	27,654
M8	41687	10	10	0,730	28452	4	12	0,900						58453	350	9	30,518
M10					28453	2	12	0,900						58454	200	9	43,972
M12					28454	2	12	0,900									

**TUERCA CIEGA**

ZINCADO  
ÉCROU BORGNE  
ACIER ZINGUÉ  
CUP NUT ZINC  
PLATED



M4					2848	4	12	0,900									
M5					2849	4	12	0,900									
M6					2850	4	12	0,900									
M8					2852	2	10	0,900									



MEDIDA: DIMENSION / SIZE | Nº PIEZAS: Nº PCS / Nº PCS | UDS. EMBALAJE: U.C. / PACKING | PRECIO TARIFA: PRIX / PRICE

MEDIDA	BOLSA SACHET BAG				PEQUEÑOS TRABAJOS BRICOLAGE D.I.Y.				CAJA PROFESIONAL PLÁSTICO BOÎTE PROFESSIONNELLE PROFESSIONAL BOX					CAJA PROFESIONAL CARTÓN BOÎTE PROFESSIONNELLE CARTON PROFESSIONAL CARTON BOX					
	REF.	Nº PIEZAS	UDS. EMBALAJE	PRECIO TARIFA	REF.	Nº PIEZAS	UDS. EMBALAJE	PRECIO TARIFA	REF.	Nº PIEZAS	UDS. EMBALAJE	UDS. PEDIDO	PRECIO TARIFA	REF.	Nº PIEZAS	UDS. EMBALAJE	PRECIO TARIFA		
<b>TUERCA MARIPOSA</b> ZINCADO ÉCROU À OREILLES ACIER ZINGUÉ WING NUT ZINC PLATED	M3				2857	8	12	1,353						5857	400	27	53,389		
	M4				2858	6	12	1,353						5858	300	27	22,249		
	M5				2859	6	12	1,353						5859	300	27	14,689		
	M6	41688	4	10	0,730	2860	4	12	1,353					5860	200	27	11,245		
	M8					2862	2	10	1,353					5862	150	27	20,923		
<b>ARANDELA PLANA</b> ZINCADO RONDELLE PLATE ÉTROITE ACIER ZINGUÉ FLAT WASHER ZINC PLATED	M3	41504	125	10	0,730	2867	125	12	0,900					5868	1000	54	5,352		
	M4	4977	90	10	0,730	2868	90	12	0,900					5869	1000	54	5,912		
	M5	4978	70	10	0,730	2869	70	12	0,900					5870	1000	54	16,792		
	M6	4979	43	10	0,730	2870	43	12	0,900										
	M7					2871	30	12	0,900										
	M8	4980	19	10	0,730	2872	19	12	0,900					5872	1000	18	22,453		
	M10	41505	12	10	0,730	2874	12	12	0,900					5874	900	9	40,902		
	M12					28743	8	12	0,900					58743	600	9	46,008		
	<b>ARANDELA PLANA ANCHA</b> ZINCADO RONDELLE PLATE LARGE ACIER ZINGUÉ FLAT LARGE WASHER ZINC PLATED	M3				28759	40	12	0,900										
		M4	41506	30	10	0,730	2876	30	12	0,900	43762	350	48	12	3,279	5876	1000	54	10,412
		M5	41507	20	10	0,730	28761	20	12	0,900	43763	180	48	12	3,279	58761	800	27	14,621
		M6	41508	15	10	0,730	28762	15	12	0,900	43764	100	48	12	3,279	58762	400	27	12,885
M8		41509	10	10	0,730	28763	10	12	0,900	43765	40	48	12	3,279	58763	300	18	20,475	
M10		41510	5	10	0,730	28764	6	12	0,900	43766	22	48	12	3,279	58764	250	9	32,738	
M12						28765	3	12	0,900	43767	12	48	12	3,279	58765	180	9	46,810	
<b>ARANDELA GROWER</b> ZINCADO RONDELLE GROWER ACIER ZINGUÉ SPRING LOCK WASHER ZINC PLATED		M4				2878	60	12	0,900										
		M5				2879	55	12	0,900										
		M6				2880	33	12	0,900										
		M8				2882	12	12	0,900										
		M10				28820	12	12	0,900										
<b>ARANDELA DENTADA</b> ZINCADO RONDELLE DENTÉE ACIER ZINGUÉ TEETH WASHER ZINC PLATED	M4				28824	60	12	1,353											
	M5				28825	45	12	1,353											
	M6				28826	30	12	1,353											
	M8				28828	20	12	1,353											
<b>ARANDELA</b> LATÓN RONDELLE PLATE ÉTROITE LAITON FLAT WASHER SOLID BRASS	M4				28754	8	12	1,353											
	M5				28755	6	12	1,353											
	M6				28756	4	12	1,353											
<b>ARANDELA</b> POLIAMIDA RONDELLE POLYAMIDE WASHER POLYAMIDE	M6				28848	4	12	3,333											



MEDIDA: DIMENSION / SIZE | Nº PIEZAS: Nº PCS / Nº PCS | UDS. EMBALAJE: U.C. / PACKING | PRECIO TARIFA: PRIX / PRICE

MEDIDA	BOLSA SACHET BAG				PEQUEÑOS TRABAJOS BRICOLAGE D.I.Y.				CAJA PROFESIONAL PLÁSTICO BOÎTE PROFESSIONNELLE PROFESSIONAL BOX					CAJA PROFESIONAL CARTÓN BOÎTE PROFESSIONNELLE CARTON PROFESSIONAL CARTON BOX			
	REF.	Nº PIEZAS	UDS. EMBALAJE	PRECIO TARIFA	REF.	Nº PIEZAS	UDS. EMBALAJE	PRECIO TARIFA	REF.	Nº PIEZAS	UDS. EMBALAJE	UDS. PEDIDO	PRECIO TARIFA	REF.	Nº PIEZAS	UDS. EMBALAJE	PRECIO TARIFA

**VARILLA ROSCADA HIERRO**

**ZINCADO 1 METRO**

TIGE FILETÉE ACIER ZINGUÉ  
THREADED ROD ZINC PLATED



M4					28851	1	1	1,114									
M5					28852	1	1	1,611									
M6					28853	1	1	1,611									
M8					28855	1	1	2,541									
M10					28857	1	1	3,898									
M12					28858	1	1	5,578									

**TORNILLO**

**CABEZA PLANA Y TUERCA**

ZINCADO  
BOULON TÊTE FRAISÉE FENDUE ACIER ZINGUÉ  
COUNTERSUNK HEAD BOLT & NUT ZINC PLATED



M3x10									43726	230	48	12	3,279				
M4x20									43727	100	48	12	3,279				
M4x30									43728	60	48	12	3,279				
M4x40									43729	40	48	12	3,279				
M5x20									43730	60	48	12	3,279				

**TORNILLO**

**CABEZA CILÍNDRICA Y TUERCA**

ZINCADO  
BOULON TÊTE CYLINDRIQUE FENDUE ACIER ZINGUÉ  
PAN HEAD BOLT & NUT ZINC PLATED



M4x20									43731	90	48	12	3,279				
M4x30									43732	50	48	12	3,279				
M4x40									43733	35	48	12	3,279				
M5x20									43734	55	48	12	3,279				

**TORNILLO**

**CABEZA ALOMADA Y TUERCA**

ZINCADO  
BOULON TÊTE BOMBÉE ACIER ZINGUÉ  
PAN OVAL HEAD BOLT & NUT ZINC PLATED



M3x10					27301	18	12	0,900									
M3x16					27302	14	12	0,900									
M3x20					27303	12	12	0,900									
M3x25					27317	12	12	0,900									
M3x30					27304	10	12	0,900									
M3x40					27318	8	12	0,900									
M3x50					27319	6	12	0,900									
M4x10					27305	14	12	0,900									
M4x16					27306	12	12	0,900									
M4x20					27307	12	12	0,900									
M4x25					27308	10	12	0,900									
M4x30					27309	10	12	0,900									
M4x35					27320	10	12	0,900									
M4x40					27310	8	12	0,900									
M4x45					27321	8	12	0,900									
M4x50					27311	6	12	0,900									
M5x10					27312	8	12	0,900									
M5x16					27313	8	12	0,900									
M5x25					27322	6	12	0,900									
M5x20					27323	8	12	0,900									
M5x30					27314	6	12	0,900									
M5x40					27324	4	12	0,900									
M5x50					27325	4	12	0,900									
M6x16					27315	4	12	0,900									
M6x20					27316	4	12	0,900									



MEDIDA: DIMENSION / SIZE | Nº PIEZAS: Nº PCS / Nº PCS | UDS. EMBALAJE: U.C. / PACKING | PRECIO TARIFA: PRIX / PRICE

MEDIDA	BOLSA SACHET BAG				PEQUEÑOS TRABAJOS BRICOLAGE D.I.Y.				CAJA PROFESIONAL PLÁSTICO BOÎTE PROFESSIONNELLE PROFESSIONAL BOX				CAJA PROFESIONAL CARTÓN BOÎTE PROFESSIONNELLE CARTON PROFESSIONAL CARTON BOX			
	REF.	Nº PIEZAS	UDS. EMBALAJE	PRECIO TARIFA	REF.	Nº PIEZAS	UDS. EMBALAJE	PRECIO TARIFA	REF.	Nº PIEZAS	UDS. EMBALAJE	UDS. PEDIDO	PRECIO TARIFA	REF.	Nº PIEZAS	UDS. EMBALAJE

**TORNILLO**  
**CABEZA HEXAGONAL Y TUERCA**

ZINCADO  
BOULON TÊTE HEXAGONALE ACIER ZINGUÉ  
HEXAGONAL HEAD BOLT & NUT ZINC PLATED



M5x20	41679	6	10	0,730													
M5x30	41680	5	10	0,730													
M6x20									43735	35	48	12	3,279				
M6x30	41681	4	10	0,730					43736	30	48	12	3,279				
M6x40									43737	25	48	12	3,279				
M6x50									43738	20	48	12	3,279				
M8x30									43739	15	48	12	3,279				

**TORNILLO**  
**CABEZA PLANA TUERCA Y ARANDELA**

ZINCADO  
BOULON TÊTE FRAISÉE FENDUE AVEC RONDELLE ACIER ZINGUÉ  
COUNTERSUNK HEAD BOLT & NUT WITH WASHER ZINC PLATED



M3x10					28941	40	12	0,900									
M3x20					28942	25	12	0,900									
M3x30					28943	14	12	0,900									
M4x20					28944	14	12	0,900									
M4x30					28945	10	12	0,900									
M4x40					28940	8	12	0,900									
M5x20					28950	10	12	0,900									
M5x30					28955	8	12	0,900									

**TORNILLO**  
**CABEZA CILÍNDRICA TUERCA Y ARANDELA**

ZINCADO  
BOULON TÊTE CYLINDRIQUE FENDUE AVEC RONDELLE ACIER ZINGUÉ  
PAN HEAD BOLT & NUT WITH WASHER ZINC PLATED



M4x20					28956	12	12	0,900									
M4x30					28957	9	12	0,900									
M4x40					28958	6	12	0,900									
M5x20					28959	8	12	0,900									
M5x40					28960	5	12	0,900									

**TORNILLO**  
**CABEZA HEXAGONAL TUERCA Y ARANDELA**

ZINCADO  
BOULON TÊTE HEXAGONALE AVEC RONDELLE ACIER ZINGUÉ  
HEXAGONAL HEAD BOLT & NUT WITH WASHER ZINC PLATED



M6x20					28946	8	12	1,353									
M6x30					28947	6	12	1,353									
M6x40					28948	5	12	1,353									
M6x50					28949	4	12	1,353									
M8x20					2895	4	10	1,353									
M8x30					28951	4	10	1,353									
M8x40					28952	3	10	1,353									
M8x50					28953	2	10	1,353									
M8x60					28954	2	10	1,353									



MEDIDA: DIMENSION / SIZE | Nº PIEZAS: Nº PCS / Nº PCS | UDS. EMBALAJE: U.C. / PACKING | PRECIO TARIFA: PRIX / PRICE

MEDIDA	BOLSA SACHET BAG				PEQUEÑOS TRABAJOS BRICOLAGE D.I.Y.				CAJA PROFESIONAL PLÁSTICO BOÎTE PROFESSIONNELLE PROFESSIONAL BOX					CAJA PROFESIONAL CARTÓN BOÎTE PROFESSIONNELLE CARTON PROFESSIONAL CARTON BOX			
	REF.	Nº PIEZAS	UDS. EMBALAJE	PRECIO TARIFA	REF.	Nº PIEZAS	UDS. EMBALAJE	PRECIO TARIFA	REF.	Nº PIEZAS	UDS. EMBALAJE	UDS. PEDIDO	PRECIO TARIFA	REF.	Nº PIEZAS	UDS. EMBALAJE	PRECIO TARIFA
<b>TACO POLIETILENO ALTA DENSIDAD</b> CHEVILLE POLYÉTHYLÈNE / PE WALL PLUG																	
4 mm	4981	22	10	0,730	2896	22	12	0,900	43520	250	24	8	3,279	5896	200	54	1,640
4 mm	● 41555	85	10	1,270													
5 mm	4982	16	10	0,730	2897	16	12	0,900	43521	200	24	8	3,279	5897	200	54	1,454
5 mm	● 41556	70	10	1,270													
6 mm	4983	12	10	0,730	2898	12	12	0,900	43522	150	24	8	3,279	5898	200	27	1,852
6 mm	● 41557	50	10	1,270													
8 mm	4984	8	10	0,730	2900	8	12	0,900	43523	60	24	8	3,279	5900	100	27	2,023
8 mm	● 41558	30	10	1,270													
10 mm	4985	4	10	0,730	2901	4	12	0,900	43524	30	24	8	3,279	5901	50	18	2,517
10 mm	● 41559	16	10	1,270													
12 mm	41511	3	10	0,730	2902	3	10	0,900	43525	15	24	8	3,279	5902	25	18	2,242
<b>TACO NYLON</b> CHEVILLE NYLON / NYLON WALL PLUG																	
4 mm														59251	200	54	2,079
5 mm														59252	200	54	2,294
6 mm														59253	200	27	3,346
8 mm														59254	100	18	4,006
10 mm														59255	50	18	4,430
12 mm														59256	25	18	3,752
<b>TACO DE POLIETILENO BLANCO</b> CHEVILLE POLYÉTHYLÈNE BLANC PE WALL PLUG WHITE																	
5 mm	45917	25	20	0,660													
6 mm	4986	15	10	0,730	29031	15	10	0,900									
6 mm	45918	25	20	0,439													
7 mm	4987	12	10	0,730	29032	15	10	0,900									
7 mm	45919	25	20	0,536													
8 mm	4988	10	10	0,730	29033	10	10	0,900									
8 mm	45920	25	20	0,555													
9 mm	4989	6	10	0,730	29034	6	10	0,900									
9 mm	45921	25	10	0,818													
10 mm	41512	5	10	0,730	29035	5	10	0,900									
10 mm	45922	25	10	0,977													
<b>TACO CON TIRAFONDO BICROMATADO</b> CHEVILLE PE & VIS AGGLO ACIER BICHROMATÉ PE WALL PLUG & CHIPBOARD SCREW YELLOW ZINC PLATED																	
4 mm-2,5x25	41689	10	10	0,730	2904	9	12	0,900	43530	100	48	12	3,279				
5 mm-3,5x30	41621	7	10	0,730	2905	7	12	0,900	43531	100	24	8	3,279				
6 mm-4,5x40	41622	5	10	0,730	2906	5	12	0,900	43532	60	24	8	3,279				
8 mm-6x50	41623	3	10	0,730	2908	3	12	0,900	43533	25	24	8	3,279				

● Se vende en bolsa amarilla







MEDIDA: DIMENSION / SIZE | Nº PIEZAS: Nº PCS / Nº PCS | UDS. EMBALAJE: U.C. / PACKING | PRECIO TARIFA: PRIX / PRICE

MEDIDA	BOLSA SACHET BAG				PEQUEÑOS TRABAJOS BRICOLAGE D.I.Y.				CAJA PROFESIONAL PLÁSTICO BOÎTE PROFESSIONNELLE PROFESSIONAL BOX				CAJA PROFESIONAL CARTÓN BOÎTE PROFESSIONNELLE CARTON PROFESSIONAL CARTON BOX				
	REF.	Nº PIEZAS	UDS. EMBALAJE	PRECIO TARIFA	REF.	Nº PIEZAS	UDS. EMBALAJE	PRECIO TARIFA	REF.	Nº PIEZAS	UDS. EMBALAJE	UDS. PEDIDO	PRECIO TARIFA	REF.	Nº PIEZAS	UDS. EMBALAJE	PRECIO TARIFA
<b>TACO CON TIRAFONDO</b>																	
<b>BICROMATADO</b> CHEVILLE PE & VIS AGGLO ACIER BICHROMATÉ PE WALL PLUG & CHIPBOARD SCREW YELLOW ZINC PLATED																	
10 mm-7x60	41690	3	10	0,730	2910	2	10	0,900	43534	12	24	8	3,279				
<b>TACO CON ESCARPIA ROSCADA</b>																	
<b>ZINCADO</b> CHEVILLE PE & GOND À VIS ACIER ZINGUÉ PE WALL PLUG & SCREW HOOK ZINC PLATED																	
4 mm-16x35	41691	10	10	0,730	2911	8	12	0,900	43740	70	48	12	3,279				
5 mm-17x50	41624	6	10	0,730	2912	6	12	0,900	43540	50	48	12	3,279				
6 mm-20x60	41625	4	10	0,730	2913	4	12	0,900	43541	25	48	12	3,279				
8 mm-21x65	41626	3	10	0,730	2915	3	12	0,900	43741	20	24	8	3,279				
<b>TACO CON HEMBRILLA ABIERTA</b>																	
<b>ZINCADO</b> CHEVILLE PE & CROCHET ACIER ZINGUÉ PE WALL PLUG & CUP HOOK ZINC PLATED																	
4 mm-16x35					2916	7	12	0,900									
5 mm-17x60	41627	6	10	0,730	2917	6	12	0,900									
6 mm-20x70	41628	4	10	0,730	2918	4	12	0,900									
8 mm-21x90	41629	2	10	0,730	2920	2	12	0,900									
<b>TACO CON HEMBRILLA CERRADA</b>																	
<b>ZINCADO</b> CHEVILLE PE & PITON ACIER ZINGUÉ PE WALL PLUG & SCREW EYE ZINC PLATED																	
4 mm-16x35	41692	10	10	0,730	2921	7	12	0,900									
5 mm-17x60	41630	5	10	0,730	2922	5	12	0,900									
6 mm-20x70	41631	4	10	0,730	2923	4	12	0,900									
8 mm-21x90	41632	2	10	0,730	2925	2	12	0,900									
<b>TACO DE CLAVAR</b>																	
<b>CHEVILLE À FRAPPER</b> NYLON HAMMER PLUG ANCHOR																	
5x30					29201	15	10	1,778	43550	20	80	10	3,279				
5x50					29202	8	10	1,778	43551	15	80	10	3,279				
6x40					29203	8	10	1,778	43552	15	80	10	3,279				
6x50					29208	8	10	1,778	43743	15	80	10	3,279				
6x60					29204	8	10A	2,533	43553	12	80	10	3,279				
6x70					29209	6	10A	2,533	43744	12	20	10	3,279				
8x60					29205	6	10A	2,533	43554	6	20	10	3,279				
8x80					29206	6	10A	2,533	43555	6	20	10	3,279				







MEDIDA: DIMENSION / SIZE | Nº PIEZAS: Nº PCS / Nº PCS | UDS. EMBALAJE: U.C. / PACKING | PRECIO TARIFA: PRIX / PRICE

MEDIDA	BOLSA SACHET BAG				PEQUEÑOS TRABAJOS BRICOLAGE D.I.Y.				CAJA PROFESIONAL PLÁSTICO BOÎTE PROFESSIONNELLE PROFESSIONAL BOX					CAJA PROFESIONAL CARTÓN BOÎTE PROFESSIONNELLE CARTON PROFESSIONAL CARTON BOX			
	REF.	Nº PIEZAS	UDS. EMBALAJE	PRECIO TARIFA	REF.	Nº PIEZAS	UDS. EMBALAJE	PRECIO TARIFA	REF.	Nº PIEZAS	UDS. EMBALAJE	UDS. PEDIDO	PRECIO TARIFA	REF.	Nº PIEZAS	UDS. EMBALAJE	PRECIO TARIFA
<b>TACO PARA PLACA DE YESO</b> CHEVILLE POUR PLAQUE DE PLÂTRE / DRYWALL PLUG 	10x38				29211	8	10	1,778	43560	10	48	12	3,279				
	10x47				29212	4	10	1,778	43561	7	80	10	3,279				
<b>TACO PARA PLACA DE YESO CON TORNILLO BICROMATADO</b> CHEVILLE POUR PLAQUE DE PLÂTRE AVEC VIS AGGLO ACIER BICHROMATÉ DRYWALL PLUG & CHIPBOARD SCREW YELLOW ZINC PLATED 	10x38				28961	4	10	1,778									
<b>TACO NYLON 4 CARAS</b> CHEVILLE NYLON / NYLON PLUG 	5 mm				29222	15	12	0,900	43769	100	24	8	3,279				
	6 mm				29223	10	12	0,900	43770	70	24	8	3,279				
	8 mm				29224	5	12	0,900	43771	30	24	8	3,279				
	10 mm				29225	4	10	0,900	43772	20	24	8	3,279				
<b>TACO NYLON 4 CARAS CON TORNILLO BICROMATADO</b> CHEVILLE NYLON AVEC VIS AGGLO ACIER BICHROMATÉ NYLON PLUG & CHIPBOARD SCREW YELLOW ZINC PLATED 	5 mm-3,5x35				28962	6	12	0,900									
	6 mm-4,5x40				28963	5	12	0,900									
	8 mm-6x50				28964	3	12	0,900									
<b>TACO NYLON 4 CARAS CON TORNILLO ZINCADO</b> CHEVILLE NYLON AVEC TREFOND ACIER ZINGUÉ NYLON PLUG & HEXAGONAL HEAD WOOD SCREW ZINC PLATED 	10 mm-6x60				28965	2	10	0,900									









MEDIDA: DIMENSION / SIZE | Nº PIEZAS: Nº PCS / Nº PCS | UDS. EMBALAJE: U.C. / PACKING | PRECIO TARIFA: PRIX / PRICE

MEDIDA	BOLSA SACHET BAG				PEQUEÑOS TRABAJOS BRICOLAGE D.I.Y.				CAJA PROFESIONAL PLÁSTICO BOÎTE PROFESSIONNELLE PROFESSIONAL BOX					CAJA PROFESIONAL CARTÓN BOÎTE PROFESSIONNELLE CARTON PROFESSIONAL CARTON BOX			
	REF.	Nº PIEZAS	UDS. EMBALAJE	PRECIO TARIFA	REF.	Nº PIEZAS	UDS. EMBALAJE	PRECIO TARIFA	REF.	Nº PIEZAS	UDS. EMBALAJE	UDS. PEDIDO	PRECIO TARIFA	REF.	Nº PIEZAS	UDS. EMBALAJE	PRECIO TARIFA
<b>TACO NYLON 4 CARAS CON ESCARPIA ROSCADA</b> ZINCADO CHEVILLE NYLON AVEC GOND À VIS ACIER ZINGUÉ NYLON PLUG & SCREW HOOK ZINC PLATED 	5 mm-17x50				28966	4	12	0,900									
	6 mm-19x60				28967	3	12	0,900									
	8 mm-21x65				28968	2	12	0,900									
<b>TACO NYLON 4 CARAS CON HEMBRILLA ABIERTA</b> ZINCADO CHEVILLE NYLON AVEC CROCHET ACIER ZINGUÉ NYLON PLUG & CUP HOOK ZINC PLATED 	5 mm-17x60				28969	4	12	0,900									
	6 mm-19x70				28971	3	12	0,900									
	8 mm-21x90				28972	2	12	0,900									
<b>TACO NYLON 4 CARAS CON HEMBRILLA CERRADA</b> ZINCADO CHEVILLE NYLON AVEC PITON ACIER ZINGUÉ NYLON PLUG & SCREW EYE ZINC PLATED 	5 mm-17x60				28973	4	12	0,900									
	6 mm-19x70				28974	3	12	0,900									
	8 mm-21x90				28975	2	12	0,900									
<b>TACO UNIVERSAL</b> CHEVILLE UNIVERSELLE MULTIPURPOSE NYLON PLUG WITH COLLAR 	5 mm				29214	12	12	0,900									
	6 mm	41513	10	10	0,730	29215	10	12	0,900	43565	70	24	8	3,279			
	8 mm	41514	5	10	0,730	29216	5	12	0,900	43566	30	24	8	3,279			
	10 mm					29217	4	10	0,900	43567	20	24	8	3,279			
<b>TACO UNIVERSAL CON TORNILLO</b> BICROMATADO CHEVILLE UNIVERSELLE & VIS AGGLO ACIER BICHOMATÉ MULTIPURPOSE NYLON PLUG WITH COLLAR & CHIPBOARD SCREW YELLOW ZINC PLATED 	5 mm-4x35				29251	6	12	0,900									
	6 mm-4,5x40				29218	5	12	0,900									
	8 mm-6x50				29219	3	12	0,900									







MEDIDA: DIMENSION / SIZE | Nº PIEZAS: Nº PCS / Nº PCS | UDS. EMBALAJE: U.C. / PACKING | PRECIO TARIFA: PRIX / PRICE

MEDIDA	BOLSA SACHET BAG				PEQUEÑOS TRABAJOS BRICOLAGE D.I.Y.				CAJA PROFESIONAL PLÁSTICO BOÎTE PROFESSIONNELLE PROFESSIONAL BOX					CAJA PROFESIONAL CARTÓN BOÎTE PROFESSIONNELLE CARTON PROFESSIONAL CARTON BOX			
	REF.	Nº PIEZAS	UDS. EMBALAJE	PRECIO TARIFA	REF.	Nº PIEZAS	UDS. EMBALAJE	PRECIO TARIFA	REF.	Nº PIEZAS	UDS. EMBALAJE	UDS. PEDIDO	PRECIO TARIFA	REF.	Nº PIEZAS	UDS. EMBALAJE	PRECIO TARIFA
<b>TACO UNIVERSAL CON TORNILLO</b> <b>BICROMATADO</b> CHEVILLE UNIVERSELLE & TREFOND ACIER BICHROMATÉ MULTIPURPOSE NYLON PLUG WITH COLLAR & HEXAGONAL HEAD WOOD SCREW YELLOW ZINC PLATED 																	
10 mm-7x60					29190	2	10	0,900									
<b>TACO UNIVERSAL CON ESCARPIA ROSCADA</b> <b>ZINCADO</b> CHEVILLE UNIVERSELLE & GOND À VIS ACIER ZINGUÉ MULTIPURPOSE NYLON PLUG WITH COLLAR & SCREW HOOK ZINC PLATED 	5 mm-17x50								43746	35	48	12	3,279				
	6 mm-20x60				29193	3	12	0,900	43747	20	48	12	3,279				
	8 mm-21x65								43748	18	24	8	3,279				
<b>TACO UNIVERSAL CON HEMBRILLA ABIERTA</b> <b>ZINCADO</b> CHEVILLE UNIVERSELLE & CROCHET ACIER ZINGUÉ MULTIPURPOSE NYLON PLUG WITH COLLAR & CUP HOOK ZINC PLATED 	5 mm-17x60								43749	25	48	12	3,279				
	6 mm-20x70								43750	14	48	12	3,279				
	8 mm-21x90								43751	12	24	8	3,279				
<b>TACO UNIVERSAL CON HEMBRILLA CERRADA</b> <b>ZINCADO</b> CHEVILLE UNIVERSELLE & PITON ACIER ZINGUÉ MULTIPURPOSE NYLON PLUG WITH COLLAR & SCREW EYE ZINC PLATED 	6 mm-20x70								43752	14	48	12	3,279				
	8 mm-21x90								43753	12	24	8	3,279				
<b>TACO DE ZAMAK PARA PLADUR</b> CHEVILLE EN ZAMAC / ZINC ALLOY DRYWALL ANCHOR 					29240	8	10	2,533									





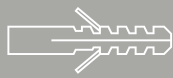

MEDIDA: DIMENSION / SIZE | N° PIEZAS: N° PCS / N° PCS | UDS. EMBALAJE: U.C. / PACKING | PRECIO TARIFA: PRIX / PRICE

MEDIDA	BOLSA SACHET BAG				PEQUEÑOS TRABAJOS BRICOLAGE D.I.Y.				CAJA PROFESIONAL PLÁSTICO BOÎTE PROFESSIONNELLE PROFESSIONAL BOX				CAJA PROFESIONAL CARTÓN BOÎTE PROFESSIONNELLE CARTON PROFESSIONAL CARTON BOX				
	REF.	N° PIEZAS	UDS. EMBALAJE	PRECIO TARIFA	REF.	N° PIEZAS	UDS. EMBALAJE	PRECIO TARIFA	REF.	N° PIEZAS	UDS. EMBALAJE	UDS. PEDIDO	PRECIO TARIFA	REF.	N° PIEZAS	UDS. EMBALAJE	PRECIO TARIFA
<p><b>TACO DE ZAMAK PARA PLADUR CON ESCARPIA ROSCADA</b></p> <p>CHEVILLE EN ZAMAC AVEC GOND À VIS ZINC ALLOY DRYWALL ANCHOR &amp; SCREW HOOK</p> 	19x40	41693	5	10	3,463	29241	5	10	3,333								
<p><b>TACO DE ZAMAK PARA PLADUR CON HEMBRILLA ABIERTA</b></p> <p>CHEVILLE EN ZAMAC AVEC CROCHET ZINC ALLOY DRYWALL ANCHOR &amp; CUP HOOK</p> 	19x60					29242	4	10	3,333								
<p><b>TACO DE ZAMAK PARA PLADUR CON HEMBRILLA CERRADA</b></p> <p>CHEVILLE EN ZAMAC AVEC PITON ZINC ALLOY DRYWALL ANCHOR &amp; SCREW EYE</p> 	19x60					29243	4	10	3,333								
<p><b>TACO DE ZAMAK PARA PLADUR CON ROSCA CHAPA</b></p> <p>CHEVILLE EN ZAMAC AVEC VIS TÔLE ZINC ALLOY DRYWALL ANCHOR &amp; SELF TAPPING SCREW</p> 	4,20x25	41694	6	10	3,463	29244	5	10	3,333								
<p><b>TACO DE NYLON PARA PLADUR CON ESCARPIA ROSCADA</b></p> <p>CHEVILLE NYLON PLACO AVEC GOND À VIS NYLON DRYWALL ANCHOR &amp; SCREW HOOK</p> 	18x60	41695	5	10	1,848	29232	10	10	3,333								



MEDIDA: DIMENSION / SIZE | Nº PIEZAS: Nº PCS / Nº PCS | UDS. EMBALAJE: U.C. / PACKING | PRECIO TARIFA: PRIX / PRICE

MEDIDA	BOLSA SACHET BAG				PEQUEÑOS TRABAJOS BRICOLAGE D.I.Y.				CAJA PROFESIONAL PLÁSTICO BOÎTE PROFESSIONNELLE PROFESSIONAL BOX				CAJA PROFESIONAL CARTÓN BOÎTE PROFESSIONNELLE CARTON PROFESSIONAL CARTON BOX				
	REF.	Nº PIEZAS	UDS. EMBALAJE	PRECIO TARIFA	REF.	Nº PIEZAS	UDS. EMBALAJE	PRECIO TARIFA	REF.	Nº PIEZAS	UDS. EMBALAJE	UDS. PEDIDO	PRECIO TARIFA	REF.	Nº PIEZAS	UDS. EMBALAJE	PRECIO TARIFA
<p><b>TACO DE NYLON PARA PLADUR CON HEMBRILLA ABIERTA</b> CHEVILLE NYLON PLACO AVEC CROCHET NYLON DRYWALL ANCHOR &amp; CUP HOOK</p> 	18x50				29233	10	10	3,333									
<p><b>TACO DE NYLON PARA PLADUR CON HEMBRILLA CERRADA</b> CHEVILLE NYLON PLACO AVEC PITON NYLON DRYWALL ANCHOR &amp; SCREW EYE</p> 	18x50				29234	10	10	3,333									
<p><b>TACO DE NYLON PARA PLADUR CON ROSCA CHAPA</b> CHEVILLE NYLON PLACO AVEC VIS TÔLE NYLON DRYWALL ANCHOR &amp; SELF TAPPING SCREW</p> 	3,90x25	41696	6	10	1,569	29235	10	10	2,533								
<p><b>TACO DE NYLON PARA PLADUR</b> CHEVILLE NYLON PLACO / NYLON DRYWALL ANCHOR</p> 		41697	8	10	1,569	29260	10	10	2,533	43754	14	80	10	3,279			
<p><b>ABRAZADERA ZINCADO</b> COLLIERS DE SERRAGE ZINGUÉ HOSE CLAMP ZINC PLATED</p> 	10-16				29261	2	12	0,900									
	16-23				29262	2	12	1,353									
	20-32				29263	2	10	2,533									







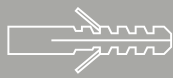

MEDIDA: DIMENSION / SIZE | Nº PIEZAS: Nº PCS / Nº PCS | UDS. EMBALAJE: U.C. / PACKING | PRECIO TARIFA: PRIX / PRICE

MEDIDA	BOLSA SACHET BAG				PEQUEÑOS TRABAJOS BRICOLAGE D.I.Y.				CAJA PROFESIONAL PLÁSTICO BOÎTE PROFESSIONNELLE PROFESSIONAL BOX				CAJA PROFESIONAL CARTÓN BOÎTE PROFESSIONNELLE CARTON PROFESSIONAL CARTON BOX				
	REF.	Nº PIEZAS	UDS. EMBALAJE	PRECIO TARIFA	REF.	Nº PIEZAS	UDS. EMBALAJE	PRECIO TARIFA	REF.	Nº PIEZAS	UDS. EMBALAJE	UDS. PEDIDO	PRECIO TARIFA	REF.	Nº PIEZAS	UDS. EMBALAJE	PRECIO TARIFA
<b>GANCHO CUEL GALÁMPARAS</b>																	
ZINCADO FIXATION À RESSORT CROCHET ZINGUÉ SPRING TOGGLE HOOK ZINC PLATED																	
4x100	● 41517	2	10	1,270	2927	1	10A	1,778						5927	40	9	24,162
5x100	● 41519	2	10	2,226	29283	1	10A	1,778						59283	35	9	25,386
<b>ESPIGA CUEL GALÁMPARAS</b>																	
ZINCADO FIXATION À RESSORT VIS ZINGUÉ SPRING TOGGLE HOOK ZINC PLATED																	
4x100	● 41518	2	10	1,270	29271	1	10A	1,778						59271	40	9	17,446
5x100					29284	1	10A	1,778						59284	35	9	25,386
<b>GANCHO CUEL GALÁMPARAS BASCULANTE</b>																	
ZINCADO FIXATION BASCULANTE CROCHET ZINGUÉ HINGED FIXING ZINC PLATED																	
4x100					29272	1	10A	1,778						59272	40	9	24,162
5x100					29285	1	10A	1,778						59285	35	9	25,386
6x100														59286	25	9	22,681
<b>ESPIGA CUEL GALÁMPARAS BASCULANTE</b>																	
ZINCADO FIXATION BASCULANTE VIS ZINGUÉ HINGED FIXING ZINC PLATED																	
4x100														59273	40	9	22,611
5x100					29287	1	10A	1,778						59287	35	9	25,198
6x100														59288	25	9	20,742
<b>ANCLAJE ZAMAK CON TORNILLO</b>																	
ANCRAGE ZAMAC AVEC VIS ZAMAC ANCHOR LOOSE BOLT																	
M6	41698	2	10	1,569	29276	1	10	1,353									

● Se vende en bolsa amarilla







MEDIDA: DIMENSION / SIZE | N° PIEZAS: N° PCS / N° PCS | UDS. EMBALAJE: U.C. / PACKING | PRECIO TARIFA: PRIX / PRICE

MEDIDA	BOLSA SACHET BAG				PEQUEÑOS TRABAJOS BRICOLAGE D.I.Y.				CAJA PROFESIONAL PLÁSTICO BOÎTE PROFESSIONNELLE PROFESSIONAL BOX					CAJA PROFESIONAL CARTÓN BOÎTE PROFESSIONNELLE CARTON PROFESSIONAL CARTON BOX			
	REF.	N° PIEZAS	UDS. EMBALAJE	PRECIO TARIFA	REF.	N° PIEZAS	UDS. EMBALAJE	PRECIO TARIFA	REF.	N° PIEZAS	UDS. EMBALAJE	UDS. PEDIDO	PRECIO TARIFA	REF.	N° PIEZAS	UDS. EMBALAJE	PRECIO TARIFA
<p><b>ANCLAJE CON TORNILLO</b></p> <p>ANCRAGE AVEC VIS ANCHOR LOOSE BOLT WITH SCREW</p> 	M6x45	41699	2	10	1,068	29277	1	10	0,900								
<p><b>ANCLAJE CON ARGOLLA</b></p> <p>ANCRAGE AVEC PITON ANCHOR LOOSE BOLT WITH SCREW EYE</p> 	M6x45	41515	2	10	1,068	29278	1	10	1,353								
<p><b>ANCLAJE CON GANCHO</b></p> <p>ANCRAGE AVEC CROCHET ANCHOR LOOSE BOLT WITH HOOK</p> 	M6x45	41516	2	10	1,068												
<p><b>TACO EXTENSIBLE CON CÂNCAMO</b></p> <p>CHEVILLE EXTENSIBLE AVEC CROCHET EXTENSIBLE ANCHOR HOOK</p> 	8 mm					29281	2	10	1,778								
<p><b>TACO NYLON GANCHO RECTO</b></p> <p>CHEVILLE NYLON AVEC GOND NYLON PLUG WITH SCREW HOOK</p> 	M4x40					29131	2	10	2,533								
	M5x45					29132	2	10	2,533								
<p><b>TACO NYLON GANCHO</b></p> <p>CHEVILLE NYLON AVEC CROCHET NYLON PLUG WITH HOOK</p> 	M4x40					29133	2	10	2,533								
	M5x45					29134	1	10	1,778								







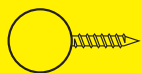

MEDIDA: DIMENSION / SIZE | Nº PIEZAS: Nº PCS / Nº PCS | UDS. EMBALAJE: U.C. / PACKING | PRECIO TARIFA: PRIX / PRICE

MEDIDA	BOLSA SACHET BAG				PEQUEÑOS TRABAJOS BRICOLAGE D.I.Y.				CAJA PROFESIONAL PLÁSTICO BOÎTE PROFESSIONNELLE PROFESSIONAL BOX					CAJA PROFESIONAL CARTÓN BOÎTE PROFESSIONNELLE CARTON PROFESSIONAL CARTON BOX			
	REF.	Nº PIEZAS	UDS. EMBALAJE	PRECIO TARIFA	REF.	Nº PIEZAS	UDS. EMBALAJE	PRECIO TARIFA	REF.	Nº PIEZAS	UDS. EMBALAJE	UDS. PEDIDO	PRECIO TARIFA	REF.	Nº PIEZAS	UDS. EMBALAJE	PRECIO TARIFA
<b>TACO NYLON ARGOLLA</b>																	
CHEVILLE NYLON AVEC PITON NYLON PLUG WITH EYE BOLT																	
																	
M4x40					29135	2	10	2,533									
M5x45					29136	1	10	1,778									
<b>TACO NYLON TORNILLO</b>																	
CHEVILLE NYLON AVEC VIS MÉTAL NYLON PLUG WITH METAL SCREW																	
																	
M4x40					29137	2	10	2,533									
M5x45					29138	2	10	2,533									
<b>TACO METÁLICO PARED HUECO CON TORNILLO</b>																	
CHEVILLE MÉTALLIQUE AVEC VIS HOLLOW WALL ANCHOR																	
																	
M4x16					29110	4	10	1,778									
M4x24					29111	4	10	1,778									
M4x33					29112	4	10	1,778									
M4x46					29113	4	10	1,778									
M5x36					29114	2	10	1,778									
M5x50					29115	2	10	1,778									
<b>TACO CARGA PESADA</b>																	
GOIJONS D'ANCRAGE HEAVY DUTY WEDGE ANCHOR																	
																	
6x55					29121	2	12	0,900									
8x65					29122	2	10	1,353									
<b>TACO CARGA PESADA EXPANSION</b>																	
DOUILLE EXPANSION HEAVY DUTY SLEEVE ANCHOR HEX BOLT TYPE																	
																	
14x50					29125	2	10	1,778									



MEDIDA: DIMENSION / SIZE | Nº PIEZAS: Nº PCS / Nº PCS | UDS. EMBALAJE: U.C. / PACKING | PRECIO TARIFA: PRIX / PRICE







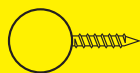

MEDIDA	BOLSA SACHET BAG				PEQUEÑOS TRABAJOS BRICOLAGE D.I.Y.				CAJA PROFESIONAL CARTÓN BOÎTE PROFESSIONNELLE CARTON PROFESSIONAL CARTON BOX			
	REF.	Nº PIEZAS	UDS. EMBALAJE	PRECIO TARIFA	REF.	Nº PIEZAS	UDS. EMBALAJE	PRECIO TARIFA	REF.	Nº PIEZAS	UDS. EMBALAJE	PRECIO TARIFA
<b>EMBELLECEDOR LISO</b> CACHE VIS & VIS SCREW COVER & SCREW												
												
14 Niquelado					2626	4	12	3,333				
14 Latonado					26262	4	12	3,333				
16 Niquelado					26264	4	12	3,333				
16 Latonado					26266	4	12	3,333				
<b>EMBELLECEDOR FACETADO</b> CACHE VIS & VIS SCREW COVER & SCREW												
												
14 Niquelado					2628	4	12	4,570				
14 Latonado					26281	4	12	4,570				
16 Niquelado					26285	4	12	4,570				
16 Latonado					26287	4	12	4,570				
<b>CIERRE MAGNÉTICO</b> LOQUETEAU MAGNÉTIQUE MAGNETIC CATCH												
												
4 kg					26331	2	10	3,333				
<b>CIERRE MAGNÉTICO</b> BLANCO LOQUETEAU MAGNÉTIQUE BLANC MAGNETIC CATCH WHITE												
												
3 kg					26335	2	10	3,333				
5 kg					26337	2	10	4,570				
<b>CIERRE MAGNÉTICO</b> MARRÓN LOQUETEAU MAGNÉTIQUE MARRON MAGNETIC CATCH BROWN												
												
2 kg					26338	2	10	3,333				
3 kg					26339	2	10	3,333				
5 kg					26341	2	10	4,570				
<b>SOPORTE DE ESPEJOS</b> PATTE À GLACE MIRROR FITTING												
												
16 Latón					26371	2	12	2,533				
16 Cromado					26373	2	12	3,333				
20 Cromado					26374	2	12	4,570				
20 Blanco					26375	2	12	5,065				

- BLANCO | BLANC | WHITE
- CROMADO | CHROMAGE | CROME PLATED
- LATÓN | LAITON | SOLID BRASS
- LATONADO | LAITONNÉ | BRASS PLATED
- NIQUELADO | NICKELÉ | NICKEL-PLATED





MEDIDA: DIMENSION / SIZE | N° PIEZAS: N° PCS / N° PCS | UDS. EMBALAJE: U.C. / PACKING | PRECIO TARIFA: PRIX / PRICE

MEDIDA	 <b>BOLSA</b> SACHET BAG				 <b>PEQUEÑOS TRABAJOS</b> BRICOLAGE D.I.Y.				 <b>CAJA PROFESIONAL</b> <b>CARTÓN</b> BOÎTE PROFESSIONNELLE CARTON PROFESSIONAL CARTON BOX			
	REF.	N° PIEZAS	UDS. EMBALAJE	PRECIO TARIFA	REF.	N° PIEZAS	UDS. EMBALAJE	PRECIO TARIFA	REF.	N° PIEZAS	UDS. EMBALAJE	PRECIO TARIFA
<b>SOPORTE ESTANTE LATÓN</b> TAQUET À VISSER LAITON / BRASS SHELF SUPPORT 					26384	4	12	2,533				
<b>SOPORTE BALDA CON ASIENTO</b> TAQUET À POINTE / SHELF SUPPORT 	Marrón				2639	10	12	0,900				
	Blanco				26395	10	12	0,900				
	Roble				26397	10	12	0,900				
<b>SOPORTE BALDA REDONDO</b> TAQUET ROND À POINTE / SHELF SUPPORT 	Marrón				2640	10	12	0,900				
	Blanco				26403	10	12	0,900				
	Roble				26406	10	12	0,900				
<b>SOPORTE CILÍNDRICO CON CASQUILLO</b> TAQUET À DOUILLE / CYLINDRIC SUPPORT 	Marrón				2641	6	12	0,900				
	Blanco				26413	6	12	0,900				
	Roble				26416	6	12	0,900				
	Latonado				26417	4	12	2,533				
<b>SOPORTE CILÍNDRICO METÁLICO</b> TAQUET À DOUILLE / METALLIC CYLINDRIC SUPPORT 	Niquelado				26411	4	12	1,353				
<b>SOPORTE ESTANTE CILÍNDRICO METÁLICO</b> TAQUET D'ÉTAGÈRE MÉTALLIQUE METALLIC CYLINDRIC SHELF SUPPORT 	Transparente				26415	4	12	0,900				

- BLANCO | BLANC | WHITE
- LATONADO | LAITONNÉ | BRASS PLATED
- MARRÓN | MARRON | BROWN

- NIQUELADO | NICKELÉ | NICKEL-PLATED
- ROBLE | CHÊNE | OAK
- TRANSPARENTE | TRANSPARENT | TRANSPARENT

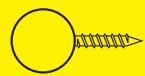

MEDIDA: DIMENSION / SIZE | N° PIEZAS: N° PCS / N° PCS | UDS. EMBALAJE: U.C. / PACKING | PRECIO TARIFA: PRIX / PRICE

MEDIDA	BOLSA SACHET BAG				PEQUEÑOS TRABAJOS BRICOLAGE D.I.Y.				CAJA PROFESIONAL CARTÓN BOÎTE PROFESSIONNELLE CARTON PROFESSIONAL CARTON BOX			
	REF.	N° PIEZAS	UDS. EMBALAJE	PRECIO TARIFA	REF.	N° PIEZAS	UDS. EMBALAJE	PRECIO TARIFA	REF.	N° PIEZAS	UDS. EMBALAJE	PRECIO TARIFA

**SOPORTE ESTANTE ESTAMPADO**

TAQUET À DOUILLE / SHELF SUPPORT



Latonado					26401	4	12	1,778				
----------	--	--	--	--	-------	---	----	-------	--	--	--	--

**SOPORTE ESTANTE PARA MADERAS**

TAQUET D'ÉTAGÈRE  
POUR BOIS

WOOD FURNITURE  
SHELF SUPPORT



Transparente					26408	4	10	1,778				
--------------	--	--	--	--	-------	---	----	-------	--	--	--	--

**SOPORTE VITRINA**

SUPPORT VITRINE / SHOWCASE SUPPORT



Blanco					26418	2	12	0,900				
--------	--	--	--	--	-------	---	----	-------	--	--	--	--

**TOPE PUERTA DE ARMARIO**

TAQUET À PRESSION / CLEAT



Blanco					26433	20	12	1,778				
--------	--	--	--	--	-------	----	----	-------	--	--	--	--

**TOPE DE SILLA CON PUNTA**

TAQUET DE CHAISE / CHAIR BUFFER WITH POINT



Marrón grande					26438	6	10	0,900				
Blanco grande					26439	6	10	0,900				
Marrón pequeño					2644	6	10	0,900				
Blanco pequeño					26442	6	10	0,900				

**TOPE PUERTA COCINA**

BLANCO  
TAQUET À POINTE BLANC / NAIL CLEAT WHITE





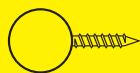

					26447	6	12	0,900				
--	--	--	--	--	-------	---	----	-------	--	--	--	--

• BLANCO | BLANC | WHITE  
• LATONADO | LATONNÉ | BRASS PLATED

• MARRÓN | MARRON | BROWN  
• TRANSPARENTE | TRANSPARENT | TRANSPARENT



MEDIDA: DIMENSION / SIZE | N° PIEZAS: N° PCS / N° PCS | UDS. EMBALAJE: U.C. / PACKING | PRECIO TARIFA: PRIX / PRICE

MEDIDA	BOLSA SACHET BAG				PEQUEÑOS TRABAJOS BRICOLAGE D.I.Y.				CAJA PROFESIONAL CARTÓN BOÎTE PROFESSIONNELLE CARTON PROFESSIONAL CARTON BOX			
	REF.	N° PIEZAS	UDS. EMBALAJE	PRECIO TARIFA	REF.	N° PIEZAS	UDS. EMBALAJE	PRECIO TARIFA	REF.	N° PIEZAS	UDS. EMBALAJE	PRECIO TARIFA
<b>TOPE PUERTA COCINA</b> <b>MARRÓN</b> TAQUET À POINTE MARRON / NAIL CLEAT BROWN 					26448	6	12	0,900				
<b>SOPORTE BALDA PLANO CON CASQUILLO</b> TAQUET ÉQUERRE À DOUILLE / SHELF SUPPORT 	Marrón				2645	4	10	0,900				
	Blanco				26452	4	10	0,900				
	Roble				26454	4	10	0,900				
<b>SOPORTE BARRA STOR BASE</b> <b>NIQUELADO</b> SUPPORT STOR NICKELÉ STOR SUPPORT NICKEL PLATED 	M12				26456	1	10	2,533				
	M16				26457	1	10	3,333				
	M20				26458	1	10	3,333				
<b>GANCHO CORTINA</b> <b>ZINCADO</b> AGRAFE ESCARGOT ACIER ZINGUÉ CURTAIN SELF HOOK ZINC PLATED 					26459	10	12	0,900				
<b>SOPORTE BARRA ARMARIO</b> SUPPORT D'ARMOIRE / CLOSET ROD SUPPORT 	Blanco				2646	2	10	0,900				
	Marrón				26461	2	10	0,900				

- BLANCO | BLANC | WHITE
- MARRÓN | MARRON | BROWN
- ROBLE | CHÊNE | OAK

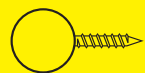

MEDIDA: DIMENSION / SIZE | N° PIEZAS: N° PCS / N° PCS | UDS. EMBALAJE: U.C. / PACKING | PRECIO TARIFA: PRIX / PRICE

MEDIDA	BOLSA SACHET BAG				PEQUEÑOS TRABAJOS BRICOLAGE D.I.Y.				CAJA PROFESIONAL CARTÓN BOÎTE PROFESSIONNELLE CARTON PROFESSIONAL CARTON BOX			
	REF.	N° PIEZAS	UDS. EMBALAJE	PRECIO TARIFA	REF.	N° PIEZAS	UDS. EMBALAJE	PRECIO TARIFA	REF.	N° PIEZAS	UDS. EMBALAJE	PRECIO TARIFA
<b>SOPORTE BARRA STOR</b>												
NIQUELADO SUPPORT STOR NICKELÉ STOR ROD SUPPORT NICKEL PLATED												
M16					26466	2	10	2,533				
M20					26463	2	10	6,272				
<b>SOPORTE BARRA LATERAL</b>												
SUPPORT TUBE DE PENDERIE CLOSET ROD SUPPORT												
Latonado					26481	2	10	2,533				
Niquelado					26482	2	10	2,533				
<b>SOPORTE BARRA LATERAL CON TAPA</b>												
SUPPORT TUBE DE PENDERIE CLOSET ROD SUPPORT												
Niquelado					26486	2	10A	5,065				
<b>SOPORTE BARRA CENTRAL</b>												
SUPPORT TUBE DE PENDERIE CLOSET ROD SUPPORT												
Latonado					26495	2	10A	5,065				
Niquelado					26496	2	10A	5,065				
<b>ANILLA SEPARADORA DE LLAVES</b>												
ANNEAU CLÉS / KEY RING												
Surtido					26539	5	12	0,900				

- LATONADO | LAITONNÉ | BRASS PLATED
- NIQUELADO | NICKELÉ | NICKEL-PLATED
- SURTIDO | ASSORTI | ASSORTMENT

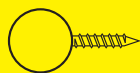

MEDIDA: DIMENSION / SIZE | N° PIEZAS: N° PCS / N° PCS | UDS. EMBALAJE: U.C. / PACKING | PRECIO TARIFA: PRIX / PRICE

MEDIDA	BOLSA SACHET BAG				PEQUEÑOS TRABAJOS BRICOLAGE D.I.Y.				CAJA PROFESIONAL CARTÓN BOÎTE PROFESSIONNELLE CARTON PROFESSIONAL CARTON BOX			
	REF.	N° PIEZAS	UDS. EMBALAJE	PRECIO TARIFA	REF.	N° PIEZAS	UDS. EMBALAJE	PRECIO TARIFA	REF.	N° PIEZAS	UDS. EMBALAJE	PRECIO TARIFA

**LLAVERO PORTAETIQUETAS**

IDENTIFICATEURS CLÉS  
KEY IDENTIFIERS



Surtido					26540	4	10	1,353				
---------	--	--	--	--	-------	---	----	-------	--	--	--	--

**ALDABILLA DE RETENIDA**

ZINCADO  
CROCHET DE CONTREVENT ACIER ZINGUÉ  
GATE HOOK ZINC PLATED



2,50x30					56259	100	54	18,712
3x40					5627	100	27	17,109
3,50x50					56270	100	18	29,120
3,50x60					56271	75	18	23,884
4x75					56256	50	18	17,755
4x100					56257	50	9	21,740
4,50x120					56258	50	9	24,683
5x140					56272	25	9	17,201
5,50x160					56273	25	9	20,100
5,50x180					56274	20	1	10,746
6x200					56275	15	1	10,802
6x250					56276	10	1	10,098
6x300					56277	10	1	11,341
6x400					56278	10	1	13,761
7x500					56279	10	1	27,489

• SURTIDO | ASSOTI | ASSORTMENT



MEDIDA: DIMENSION / SIZE | Nº PIEZAS: Nº PCS / Nº PCS | UDS. EMBALAJE: U.C. / PACKING | PRECIO TARIFA: PRIX / PRICE



PEQUEÑOS TRABAJOS  
BRICOLAGE  
D.I.Y.



CAJA PROFESIONAL  
CARTÓN  
BOÎTE PROFESSIONNELLE CARTON  
PROFESSIONAL CARTON BOX

MEDIDA	REF.	Nº PIEZAS	UDS. EMBALAJE	PRECIO TARIFA	REF.	Nº PIEZAS	UDS. EMBALAJE	PRECIO TARIFA
<b>TORNILLO</b> <b>CABEZA PLANA</b> ACERO INOXIDABLE VIS MÉTAUX TÊTE FRAISÉE FENDUE INOX SLOTTED FLAT HEAD METAL SCREW STAINLESS STEEL	M3x20	2929	10	12	1,364			
	M3x25	29291	10	12	1,364			
	M3x30	29292	10	12	1,364			
	M4x16	29294	10	12	1,364			
	M4x20	2930	8	12	1,364			
	M4x25	29301	8	12	1,364			
	M4x30	2931	8	12	1,364			
	M5x16	29314	8	12	1,364			
	M5x20	29315	5	12	1,364			
	M5x25	29316	5	12	1,364			
	M5x30	29317	5	12	1,364			
	M5x40	29318	5	12	1,364			
	M6x16	29321	5	12	1,364			
	M6x20	29322	5	12	1,364			
	M6x25	29323	4	12	1,364			
	M6x30	29324	4	12	1,364			
M6x40	29325	4	12	1,364				

**TORNILLO**  
**CABEZA CILÍNDRICA**  
ACERO INOXIDABLE  
VIS MÉTAUX TÊTE CYLINDRIQUE FENDUE INOX  
SLOTTED PAN HEAD METAL SCREW STAINLESS STEEL



M3x16	29327	10	12	1,364				
M3x20	29328	10	12	1,364				
M3x25	29329	10	12	1,364				
M3x30	29331	10	12	1,364				
M4x16	29334	10	12	1,364				
M4x20	29335	8	12	1,364				
M4x25	29336	8	12	1,364				
M4x30	29337	7	12	1,364				
M5x16	29339	8	12	1,364				
M5x20	29341	5	12	1,364				
M5x25	29342	5	12	1,364				
M5x30	29343	4	12	1,364				
M5x40	29344	4	12	1,364				
M6x16	29345	5	12	1,364				
M6x20	29346	5	12	1,364				
M6x25	29347	4	12	1,364				
M6x30	29348	4	12	1,364				
M6x40	29349	4	12	1,364				



MEDIDA: DIMENSION / SIZE | Nº PIEZAS: Nº PCS / Nº PCS | UDS. EMBALAJE: U.C. / PACKING | PRECIO TARIFA: PRIX / PRICE



**PEQUEÑOS TRABAJOS**  
BRICOLAGE  
D.I.Y.



**CAJA PROFESIONAL  
CARTÓN**  
BOÎTE PROFESSIONNELLE CARTON  
PROFESSIONAL CARTON BOX

MEDIDA	REF.	Nº PIEZAS	UDS. EMBALAJE	PRECIO TARIFA	REF.	Nº PIEZAS	UDS. EMBALAJE	PRECIO TARIFA
<b>TORNILLO</b> <b>CABEZA HEXAGONAL</b> ACERO INOXIDABLE VIS MÉTAUX TÊTE HEXAGONALE INOX HEXAGONAL HEAD METAL SCREW STAINLESS STEEL	M4x20	2935	5	12	1,364			
	M4x30	2936	5	12	1,364			
	M5x20	29362	5	12	1,364			
	M5x25	29363	5	12	1,364			
	M5x30	29364	5	12	1,364			
	M5x40	29365	4	12	1,364			
	M6x16	29367	5	12	1,364			
	M6x20	2937	4	12	1,364			
	M6x25	29371	5	12	1,364			
	M6x30	2938	4	12	1,364			
	M6x40	2939	3	12	1,364			
	M6x50	2940	2	12	1,364			
	M6x60	29400	2	10	1,364			
	M8x20	29401	2	10	1,364			
	M8x30	29402	2	10	1,364			
	M8x40	29403	1	10	1,364			
	M8x50	29404	1	10	1,364			
	M8x60	29405	1	10	1,364			
M8x80	29406	1	10	3,030				
<b>TORNILLO PARA AGLOMERADO Y MADERA</b> <b>CABEZA PLANA POZI</b> ACERO INOXIDABLE VIS AGGLO TÊTE FRAISÉE POZI INOX FLAT HEAD POZI CHIPBOARD SCREW STAINLESS STEEL	3x20	2946	7	12	1,364			
	3,50x16	29457	7	12	1,364			
	3,50x20	29458	6	12	1,364			
	3,50x25	29459	6	12	1,364			
	3,50x30	29461	5	12	1,364			
	3,50x35	29462	5	12	1,364			
	4x20	29460	5	12	1,364			
	4x25	29469	5	12	1,364			
	4x30	29463	4	12	1,364			
	4x35	2947	4	12	1,364			
	4x40	29464	4	12	1,364			
	4x50	29465	3	12	1,364			
	4,50x30	29470	4	12	1,364			
	4,50x40	29471	4	12	1,364			
	4,50x50	29467	3	12	1,364			
	5x40	29472	3	12	1,364			
	5x50	29473	3	12	1,364			
	5x60	29468	2	12	1,364			
<b>TIRAFONDO ROSCA MADERA</b> <b>CABEZA HEXAGONAL</b> ACERO INOXIDABLE TIRAFOND INOX HEXAGONAL HEAD WOOD SCREW STAINLESS STEEL	6x30	29474	3	12	1,364			
	6x40	29475	2	12	1,364			
	6x50	29476	2	12	1,364			
	6x60	29477	2	12	1,364			





MEDIDA: DIMENSION / SIZE | Nº PIEZAS: Nº PCS / Nº PCS | UDS. EMBALAJE: U.C. / PACKING | PRECIO TARIFA: PRIX / PRICE

MEDIDA	 <b>PEQUEÑOS TRABAJOS</b> BRICOLAGE D.I.Y.				 <b>CAJA PROFESIONAL</b> <b>CARTÓN</b> BOÎTE PROFESSIONNELLE CARTON PROFESSIONAL CARTON BOX			
	REF.	Nº PIEZAS	UDS. EMBALAJE	PRECIO TARIFA	REF.	Nº PIEZAS	UDS. EMBALAJE	PRECIO TARIFA
<b>TUERCA HEXAGONAL</b>								
ACERO INOXIDABLE ÉCROU HEXAGONAL INOX HEXAGONAL NUT STAINLESS STEEL								
M3	2948	20	12	1,364				
M4	2949	20	12	1,364				
M5	2950	10	12	1,364				
M6	2951	8	12	1,364				
M8	2952	4	12	1,364				
M10	29521	2	12	1,364				
<b>TUERCA CIEGA</b>								
ACERO INOXIDABLE ÉCROU BORGNE INOX CUP NUT STAINLESS STEEL								
M4	2955	2	12	1,364				
M5	29552	2	12	1,364				
M6	2957	2	12	1,364				
<b>TUERCA AUTOBLOCANTE</b>								
ACERO INOXIDABLE ÉCROU INDESSERRABLE INOX SELF LOCKING NUT STAINLESS STEEL								
M4	29580	6	12	1,364				
M6	29581	4	12	1,364				
M8	29582	3	12	1,364				
<b>TUERCA MARIPOSA</b>								
ACERO INOXIDABLE ÉCROU À OREILLES INOX WING NUT STAINLESS STEEL								
M4	29591	2	12	1,364				
M5	29592	2	12	1,364				
M6	29593	2	12	1,364				
<b>ARANDELA PLANA</b>								
ACERO INOXIDABLE RONDELLE PLATE ÉTROITE INOX FLAT WASHER STAINLESS STEEL								
M3	2960	50	12	1,364				
M4	2961	40	12	1,364				
M5	29611	30	12	1,364				
M6	2963	15	12	1,364				
M8	2964	10	12	1,364				
M10	29640	6	12	1,364				





MEDIDA: DIMENSION / SIZE | Nº PIEZAS: Nº PCS / Nº PCS | UDS. EMBALAJE: U.C. / PACKING | PRECIO TARIFA: PRIX / PRICE



**PEQUEÑOS TRABAJOS**  
BRICOLAGE  
D.I.Y.



**CAJA PROFESIONAL  
CARTÓN**  
BOÎTE PROFESSIONNELLE CARTON  
PROFESSIONAL CARTON BOX

MEDIDA	REF.	Nº PIEZAS	UDS. EMBALAJE	PRECIO TARIFA	REF.	Nº PIEZAS	UDS. EMBALAJE	PRECIO TARIFA
<b>ARANDELA PLANA ANCHA</b> ACERO INOXIDABLE RONDELLE PLATE LARGE INOX FLAT LARGE WASHER STAINLESS STEEL	M3	29651	25	12	1,364			
	M4	29652	20	12	1,364			
	M5	29653	10	12	1,364			
	M6	29654	8	12	1,364			
	M8	29655	4	12	1,364			
	M10	29656	2	12	1,364			



**TORNILLO ROSCA CHAPA**  
**CABEZA ALOMADA**  
ACERO INOXIDABLE  
VIS TÔLE TÊTE CYLINDRIQUE BOMBÉE INOX  
PHILLIPS PAN HEAD SELF TAPPING SCREW  
STAINLESS STEEL



2,90x10	2967	10	12	1,364				
3,50x13	2968	8	12	1,364				
3,50x16	29681	10	12	1,364				
3,50x19	29682	6	12	1,364				
3,50x22	29683	6	12	1,364				
3,50x25	29684	6	12	1,364				
3,90x9,5	29685	8	12	1,364				
3,90x13	29686	8	12	1,364				
3,90x16	2969	7	12	1,364				
3,90x19	29691	6	12	1,364				
3,90x22	29692	6	12	1,364				
3,90x25	29690	6	12	1,364				
4,20x13	29693	6	12	1,364				
4,20x16	29694	6	12	1,364				
4,20x19	2970	5	12	1,364				
4,20x22	29701	5	12	1,364				
4,20x25	29702	5	12	1,364				
4,20x32	29703	5	12	1,364				
4,80x13	29704	5	12	1,364				
4,80x19	29705	5	12	1,364				
4,80x22	29706	4	12	1,364				
4,80x25	2971	3	12	1,364				
4,80x32	29711	4	12	1,364				
4,80x38	29712	3	12	1,364				
4,80x50	29713	3	12	1,364				
5,50x25	29715	3	12	1,364				
5,50x38	29716	2	12	1,364				

**TORNILLO ROSCA CHAPA**  
**CABEZA PLANA**  
ACERO INOXIDABLE  
VIS TÔLE TÊTE FRAISÉE PHILLIPS INOX  
PHILLIPS COUNTERSUNK HEAD SELF TAPPING  
SCREW STAINLESS STEEL



2,90x10	2973	10	12	1,364				
3,50x13	2974	8	12	1,364				
3,50x16	29741	10	12	1,364				
3,50x19	29742	6	12	1,364				
3,50x22	29743	6	12	1,364				
3,50x25	29744	6	12	1,364				
3,90x13	29746	8	12	1,364				
3,90x16	2975	7	12	1,364				
3,90x19	29751	6	12	1,364				
3,90x22	29752	6	12	1,364				
4,20x16	29754	6	12	1,364				

Continúa en la página siguiente ►►



MEDIDA: DIMENSION / SIZE | Nº PIEZAS: Nº PCS / Nº PCS | UDS. EMBALAJE: U.C. / PACKING | PRECIO TARIFA: PRIX / PRICE



**PEQUEÑOS TRABAJOS**  
BRICOLAGE  
D.I.Y.



**CAJA PROFESIONAL  
CARTÓN**  
BOÎTE PROFESSIONNELLE CARTON  
PROFESSIONAL CARTON BOX

Continuación de página anterior

**TORNILLO ROSCA CHAPA**

**CABEZA PLANA**

ACERO INOXIDABLE

VIS TÔLE TÊTE FRAISÉE BOMBÉE INOX  
FLAT HEAD SELF TAPPING SCREW STAINLESS STEEL



MEDIDA	REF.	Nº PIEZAS	UDS. EMBALAJE	PRECIO TARIFA	REF.	Nº PIEZAS	UDS. EMBALAJE	PRECIO TARIFA
4,20x19	2976	5	12	1,364				
4,20x22	29761	6	12	1,364				
4,20x25	29762	5	12	1,364				
4,20x32	29763	5	12	1,364				
4,80x22	29765	5	12	1,364				
4,80x25	2977	3	12	1,364				
4,80x32	29771	4	12	1,364				
4,80x38	29772	3	12	1,364				
4,80x50	29774	2	12	1,364				

**TORNILLO ROSCA CHAPA**

**CABEZA GOTA SEBO**

ACERO INOXIDABLE

VIS TÔLE TÊTE BOMBÉE INOX  
OVAL HEAD SELF TAPPING SCREW STAINLESS STEEL



3,50x13	29720	8	12	1,364				
3,50x16	29721	8	12	1,364				
4,20x13	29722	6	12	1,364				
4x20x19	29723	5	12	1,364				
4,20x22	29724	5	12	1,364				
4,80x16	29725	5	12	1,364				
4,80x22	29726	5	12	1,364				
4,80x32	29727	4	12	1,364				

**VARILLA ROSCADA**

ACERO INOXIDABLE

1 METRO  
TIGE FILETÉE INOX / THREADED ROD STAINLESS STEEL



M4	29781	1	1	4,392				
M5	29782	1	1	4,392				
M6	29783	1	1	4,392				
M8	29784	1	1	7,142				
M10	29785	1	1	11,108				

**ESCARPIA ROSCADA**

ACERO INOXIDABLE

GOND À VIS / SQUARE SCREW HOOK



14x25	2979	10	12	1,364	5979	500	54	25,957
16x30	2980	9	12	1,364	5980	300	54	19,919
17x40	2981	8	12	1,364	5981	300	27	30,790
18x50	2982	6	12	1,364	5982	300	27	44,779
19x60	2983	4	12	1,364	5983	200	27	48,299
20x70	2984	2	12	1,364	5984	200	18	87,722
21x80	29842	2	12	1,364	59842	100	18	49,662

**HEMBRILLA ABIERTA**

ACERO INOXIDABLE

CROCHET OUVERT INOX / CUP HOOK STAINLESS STEEL



14x25	2985	10	12	1,364	5985	500	54	24,268
16x30	2986	8	12	1,364	5986	300	54	27,045
17x40	2987	6	12	1,364	5987	300	27	34,732
18x50	2988	5	12	1,364	5988	300	18	52,571
19x60	2989	4	12	1,364	5989	200	18	50,779
20x70	2990	2	12	1,364	5990	200	9	72,770
21x80	29904	2	12	1,364	59904	100	9	57,320

**HEMBRILLA CERRADA**

ACERO INOXIDABLE

PITON FERMÉ INOX / SCREW EYE STAINLESS STEEL



14x25	2991	10	12	1,364	5991	500	54	28,485
16x30	2992	7	12	1,364	5992	300	54	22,216
17x40	2993	6	12	1,364	5993	300	27	34,732
18x50	2994	5	12	1,364	5994	300	18	52,546
19x60	2995	3	12	1,364	5995	200	18	54,639
20x70	2996	2	12	1,364	5996	200	9	68,320
21x80	29964	2	12	1,364	59964	100	18	39,072

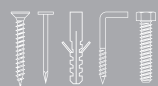

COMPOSICIÓN: COMPOSITION / COMPOSITION | UDS. EMBALAJE: U.C. / PACKING | PRECIO TARIFA: PRIX / PRICE

**SURTIDOS DE 3 CAVIDADES**

BOÎTE ASSORTEUR 3 COMPARTIMENTS  
3 COMPARTMENTS ASSORTED BOXES



COMPOSICIÓN	REF.	UDS. EMBALAJE	PRECIO TARIFA
ESCARPIA ROSCADA ZINCADO	800	12 L	1,657
HEMRILLA ABIERTA ZINCADO	801	12 L	1,657
HEMRILLA CERRADA ZINCADO	802	12 L	1,657
GANCHO CUELGACUADROS LATONADO	803	12 L	1,657
PUNTA ACERO C/PLANA ZINCADO	804	12 L	1,657
PUNTA ACERO C/CÓNICA COBREADO	805	12 L	1,657
PUNTA ACERO C/CÓNICA ZINCADO	806	12 L	1,657
PUNTA HIERRO C/PLANA ZINCADO	807	12 L	1,657
PUNTA HIERRO C/PERDIDA ZINCADO	808	12 L	1,657
GRAPAS CONDUCTORES BLANCO	809	12 L	1,657
TORNILLO PARA AGLOMERADO Y MADERA C/PLANA POZI ZINCADO	811	12 L	1,657
TORNILLO PARA AGLOMERADO Y MADERA C/REDONDA POZI ZINCADO	813	12 L	1,657
TORNILLO C/PLANA CON TUERCA ZINCADO	819	12 L	1,657
TORNILLO C/CILÍNDRICA CON TUERCA ZINCADO	820	12 L	1,657
TORNILLO R/CHAPA ZINCADO	822	12 L	1,657
TACO GRIS	823	12 L	1,657
TACO GRIS CON TIRAFONDO	824	12 L	1,657
TACO GRIS CON ESCARPIA ROSCADA ZINCADO	825	12 L	1,657
TACO GRIS CON HEMBRILLA ABIERTA ZINCADO	826	12 L	1,657
TACO GRIS CON HEMBRILLA CERRADA ZINCADO	827	12 L	1,657
CUELGACUADROS	829	12L	1,657
GRAMPILLÓN ZINCADO	830	12L	1,657
TORNILLO AUTOTALADRANTE C/ALOMADA ZINCADO	833	12L	1,657

**ESTUCHE SURTIDO**

BOÎTE ASSORTEUR / ASSORTED BOXES



COMPOSICIÓN	REF.	UDS. EMBALAJE	PRECIO TARIFA
TORNILLOS PARA AGLOMERADO Y MADERA POZI	842	10	4,958
TORNILLOS AUTOTALADRANTES CABEZA ALOMADA	843	10	6,185
CUELGACUADROS	844	10	4,958
TORNILLOS PARA METALES	851	9	4,958
PUNTAS DE HIERRO	856	10	4,958
TIRAFONDOS	860	10	4,958
PUNTAS DE ACERO CABEZA/PLANA	861	10	4,958
TORNILLOS ROSCA/CHAPA	863	10	5,218
ESCARPIAS Y HEMBRILLAS	864	10	6,185
TACOS DE 4-5-6-8-10	865	10	4,958
TACOS DE 4-5-6HEMRILLAS-ESCARPIAS-TIRAFONDOS	866	10	5,218
BROCA DE 4-TACOS-HEMRILLAS-ESCARPIAS-TIRAFONDOS	870	10	5,218
BROCA DE 5-TACOS-HEMRILLAS-ESCARPIAS-TIRAFONDOS	871	10	5,218
BROCA DE 6-TACOS-HEMRILLAS-ESCARPIAS-TIRAFONDOS	872	10	5,218
BROCA DE 4-6-8 Y TACOS 4-6-8	874	10	5,218



**GAMA DE VARILLAS ROSCADAS (1 M) DE HIERRO E INOXIDABLE**

TIGE FILETÉE ACIER ZINGUÉ ET INOX  
THREADED RODS ZINS PLATED AND STAINLESS STEEL



Imagen del expositor completo.

Imágenes de detalle de las etiquetas plásticas (más resistentes a la fricción) que individualmente lleva cada varilla con los diferentes datos, incluido el código de barras.



DESCRIPCIÓN	REF.	UDS. EMBALAJE	PRECIO TARIFA	IMPLANT. EXPOSITOR	
				CANTIDAD	TARIFA
VARILLA ROSCADA HIERRO M4 ZINCADA	28851	20	1,114 €	20	15,58 €
VARILLA ROSCADA HIERRO M5 ZINCADA	28852	20	1,611 €	20	23,42 €
VARILLA ROSCADA HIERRO M6 ZINCADA	28853	20	1,611 €	20	23,42 €
VARILLA ROSCADA HIERRO M8 ZINCADA	28855	10	2,541 €	20	43,86 €
VARILLA ROSCADA HIERRO M10 ZINCADA	28857	10	3,898 €	20	57,72 €
VARILLA ROSCADA HIERRO M12 ZINCADA	28858	10	5,578 €	20	87,72 €
VARILLA ROSCADA M4 INOX	29781	20	4,392 €	20	87,84 €
VARILLA ROSCADA M5 INOX	29782	20	4,392 €	20	87,84 €
VARILLA ROSCADA M6 INOX	29783	20	4,392 €	20	87,84 €
VARILLA ROSCADA M8 INOX	29784	10	7,142 €	20	135,48 €
VARILLA ROSCADA M10 INOX	29785	10	11,108 €	20	207,92 €
<b>EXPOSITOR SIN CARGO PARA IMPLANTACIONES COMPLETAS.</b>				<b>TOTAL TARIFA IMPLANTACIÓN EXPOSITOR (a este precio se le aplicará el descuento comercial correspondiente)</b>	
				955,58 €	

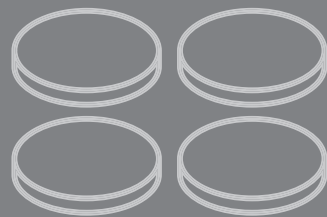
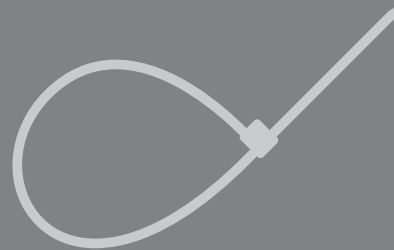
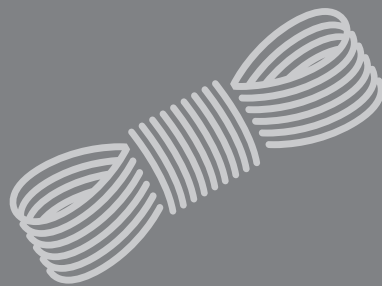
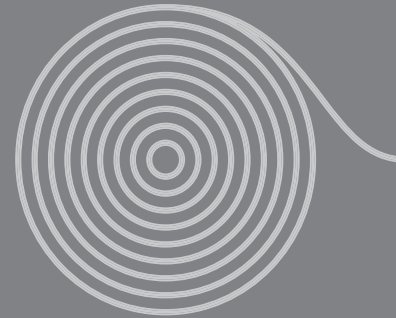
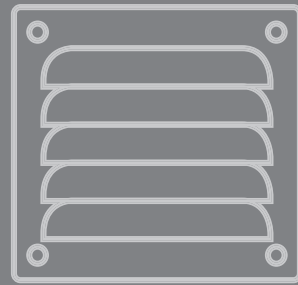
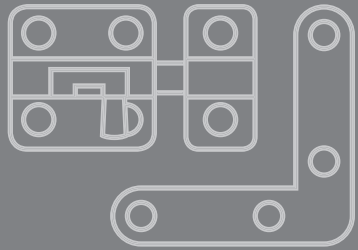

# QUINCALLERÍA

QUINCALLERIE / HARDWARE



MEDIDA: DIMENSION / SIZE | ACABADO: FINITION / FINISH | Nº PIEZAS: Nº PCS / Nº PCS | UDS. EMBALAJE: U.C. / PACKING | PRECIO TARIFA: PRIX / PRICE

**PASADOR TIPO CERROJO**

GOUPILLE • LOCK BOLT



MEDIDA	ACABADO	REF.	Nº PIEZAS	UDS. EMBALAJE	PRECIO TARIFA
30 mm	NIQUELADO	41751	1	12	1,599
40 mm	NIQUELADO	41752	1	12	1,794
50 mm	NIQUELADO	41874	1	12	2,184
60 mm	NIQUELADO	41875	1	12	2,344
30 mm	LATONADO	41876	1	12	1,606
35 mm	LATONADO	41877	1	12	1,755
40 mm	LATONADO	41878	1	12	1,871
50 mm	LATONADO	41879	1	12	2,252

**PASADOR BASE PLÁSTICO NEGRA**

GOUPILLE • LOCK BOLT



35 mm	DORADO	45896	1	12	2,398
35 mm	BLANCO	45897	1	12	2,324
50 mm	DORADO	45898	1	12	2,772
50 mm	BLANCO	45899	1	12	2,705

**MIRILLA**

JUDAS OPTIQUE • SPYHOLE



12x35 mm	LATÓN	45739	1	12	1,736
14x35 mm	LATÓN	45740	1	12	2,631

**CIERRE DE LIRA**

FERMOIR LYRE • CATCH



	ZINCADO	41884	2	12	1,828
--	---------	-------	---	----	-------

**CIERRE MAGNÉTICO**

FERMETURE MAGNÉTIQUE • MAGNETIC CATCH



35x15 mm	MARRÓN	41748	2	12	2,308
----------	--------	-------	---	----	-------

**COLGADOR ARMARIO**

CROCHET ARMOIRE • WARDROBE HANGER RAIL



53 mm	ZINCADO	41900	2	12	1,810
-------	---------	-------	---	----	-------

**PERNIO CANTO REDONDO**

CHARNIÈRE • HINGE



9,5 cm DCHA.	LATONADO	41901	3	12	4,814
9,5 cm IZDA.	LATONADO	41902	3	12	4,814

**BISAGRA BRAZO ACODADO CAZOLETA**

CHARNIÈRE • HINGE



MEDIDA	ACABADO	REF.	Nº PIEZAS	UDS. EMBALAJE	PRECIO TARIFA
26 mm	ZAMAK	41893	2	12	3,010
35 mm	ZAMAK	41894	2	12	3,528

**BISAGRA DE HIERRO FINAL ALTO**

CHARNIÈRE • HINGE



25x25 mm	LATONADO	41856	2	12	2,573
35x30 mm	LATONADO	41885	2	12	2,665
40x35 mm	LATONADO	41886	2	12	2,734
50x40 mm	LATONADO	45741	2	12	3,009
60x40 mm	LATONADO	41887	2	12	3,198
70x50 mm	LATONADO	45742	2	12	3,634

**BISAGRA DE HIERRO FINAL CHATO**

CHARNIÈRE • HINGE

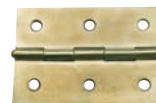

35x30 mm	LATONADO	41888	2	12	2,632
40x35 mm	LATONADO	41889	2	12	2,701
50x40 mm	LATONADO	41890	2	12	2,976
60x40 mm	LATONADO	41891	2	12	3,164
70x50 mm	LATONADO	41892	2	12	3,454

**TENSOR**

TENDEUR • TENSIONER



3/16"	GALVANIZADO	41802	2	12	3,556
1/4"	GALVANIZADO	41903	2	12	5,034

**ALDABILLA RETENIDA**

CROCHET VOLET • GATEHOOK



3,5x50	ZINCADO	41897	2	12	0,900
4x75	ZINCADO	41804	2	12	1,020
4x100	ZINCADO	41805	2	12	1,262
4,50x120	ZINCADO	41806	2	12	1,443

**CERRADURA BUZÓN RECTA (2 LLAVES)**

SERRURE • LOCK



	ZINCADO	41895	1	12	8,165
--	---------	-------	---	----	-------

**CERRADURA BUZÓN CURVA (2 LLAVES)**

SERRURE • LOCK



	ZINCADO	41896	1	12	8,165
--	---------	-------	---	----	-------

- BLANCO | BLANC | WHITE
- DORADO | DORÉ | GOLDEN
- GALVANIZADO | GALVANISÉE | GALVANIZED

- LATÓN | LAITON | SOLID BRASS
- LATONADO | LAITONNÉ | BRASS PLATED
- MARRÓN | MARRON | BROWN

- NIQUELADO | NICKELÉ | NICKEL-PLATED
- ZAMAK
- ZINCADO | ZINGUÉ | ZINC PLATED

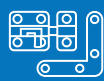

MEDIDA: DIMENSION / SIZE | ACABADO: FINITION / FINISH | N° PIEZAS: N° PCS / N° PCS | UDS. EMBALAJE: U.C. / PACKING | PRECIO TARIFA: PRIX / PRICE

**POLEA TENDEDERO CON TIRAFONDO**

POULIE TENDEUR AVEC VIS AGGLO  
PULLEY FOR CLOTHES DRYER WITH SCREW



MEDIDA	ACABADO	REF.	N° PIEZAS	UDS. EMBALAJE	PRECIO TARIFA
40 mm	ZINCADO	41904	2	12	2,427

**POLEA TENDEDERO CON TORNILLO**

POULIE TENDEUR AVEC VIS METAL  
PULLEY FOR CLOTHES DRYER WITH METAL SCREW



MEDIDA	ACABADO	REF.	N° PIEZAS	UDS. EMBALAJE	PRECIO TARIFA
40 mm	ZINCADO	41905	2	12	2,440

**SOPORTE VITRINA**

SUPPORT VITRINE • SHOWCASE SUPPORT



PEQUEÑO	BLANCO	41761	12	12	1,415
PEQUEÑO	MARRÓN	41762	12	12	1,415
GRANDE	BLANCO	41763	8	12	1,288
GRANDE	MARRÓN	41764	8	12	1,288

**SOPORTE VITRINA REDONDO**

SUPPORT VITRINE • SHOWCASE SUPPORT



	MARRÓN	41766	12	12	1,713
	BLANCO	41765	12	12	1,713

**SOPORTE VITRINA 2 PUNTAS**

SUPPORT VITRINE DEUX POINTES  
SHOWCASE SUPPORT TWO POINTS



	BLANCO	41836	12	12	1,229
	MARRÓN	41837	12	12	1,229

**FIJACIONES PEQUEÑOS MUEBLES**

ATTACHE MEUBLE  
FURNITURE HANGER



25x40 mm	ZINCADO	41778	8	12	1,605
----------	---------	-------	---	----	-------

**FIJACIONES PEQUEÑOS MUEBLES**

ATTACHE MEUBLE  
FURNITURE HANGER



60 mm	ZINCADO	41779	6	12	1,568
-------	---------	-------	---	----	-------

**PLACA DE UNIÓN**

PLAQUE D'UNION • ASSEMBLY LUGS



35x15 mm	BICROMATADO	41780	4	12	1,227
55x17 mm	BICROMATADO	41781	4	12	1,313
75x20 mm	BICROMATADO	41782	4	12	1,403
95x20 mm	BICROMATADO	41783	4	12	1,686

- BICROMATADO | BICHROMATÉ | YELLOW ZINC PLATED
- BLANCO | BLANC | WHITE
- MARRÓN | MARRON | BROWN
- PINO | PIN | PINE
- ROBLE | CHÊNE | OAK
- ZINCADO | ZINGUÉ | ZINC PLATED

**ESCUADRA PLANA**

ÉQUERRE PLATE • FLAT SQUARE



MEDIDA	ACABADO	REF.	N° PIEZAS	UDS. EMBALAJE	PRECIO TARIFA
40 mm	BICROMATADO	41784	4	12	1,150
50 mm	BICROMATADO	41785	4	12	1,082
60 mm	BICROMATADO	41786	4	12	1,466
80 mm	BICROMATADO	41910	4	12	1,990

**ESCUADRA DE ÁNGULO**

ÉQUERRE D'ANGLE • ANGLE SUPPORT BRACKETS



20 mm	BICROMATADO	41852	4	12	1,091
30 mm	BICROMATADO	41787	4	12	1,258
40 mm	BICROMATADO	41788	4	12	1,333
50 mm	BICROMATADO	41789	4	12	1,430
60 mm	BICROMATADO	41790	4	12	1,546
70 mm	BICROMATADO	41906	4	12	1,969
80 mm	BICROMATADO	41907	4	12	1,917
100 mm	BICROMATADO	41908	4	12	2,079

**ESCUADRA DE HIERRO ESTAMPADO**

ÉQUERRE FER • IRON SQUARE



30 mm	ZINCADO	41853	2	12	1,181
75 mm	ZINCADO	41909	2	12	3,192
30 mm	BICROMATADO	45751	2	12	1,214
50 mm	BICROMATADO	41854	2	12	2,167

**POMO**

POIGNÉE • FURNITURE KNOB



30 mm	ROBLE	41898	2	12	3,973
40 mm	ROBLE	41899	2	12	4,556

**POMO**

POIGNÉE • FURNITURE KNOB



25 mm	PINO	45745	2	12	2,456
-------	------	-------	---	----	-------

**ASA DE ARMARIO**

POIGNÉE DE MEUBLE • FURNITURE HANDLE



96 mm	PINO	45746	1	12	2,906
-------	------	-------	---	----	-------

**ASA DE ARMARIO**

POIGNÉE DE MEUBLE • FURNITURE HANDLE



96 mm	ROBLE	45747	1	12	2,906
-------	-------	-------	---	----	-------

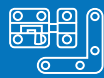

MEDIDA: DIMENSION / SIZE | ACABADO: FINITION / FINISH | N° PIEZAS: N° PCS / N° PCS | UDS. EMBALAJE: U.C. / PACKING | PRECIO TARIFA: PRIX / PRICE

**LLAVERO PORTA-ETIQUETAS**

IDENTIFICATEURS CLÉS • KEY IDENTIFIERS



MEDIDA	ACABADO	REF.	N° PIEZAS	UDS. EMBALAJE	PRECIO TARIFA
	SURTIDO	41760	8	12	1,960

**GRILLETE**

MANILLE • SHACKLE



8 mm	GALVANIZADO	41917	2	12	1,837
------	-------------	-------	---	----	-------

**SUJETACABLES**

SUPPORT DE CÂBLES • CABLE CLAMP



3/16"	GALVANIZADO	41803	2	12	0,754
-------	-------------	-------	---	----	-------

**ANILLA GIRATORIA**

ANNEAU TOURNANT • ROTATING RING



1,5x51 mm	NIQUELADO	45900	1	12	1,620
-----------	-----------	-------	---	----	-------

**GANCHO FORMA "S"**

CROCHET FORME "S" • HOOKS "S"



50 mm	ZINCADO	41918	4	12	1,147
-------	---------	-------	---	----	-------

**MOSQUETÓN ALUMINIO COLOR**

MOUSQUETON ALUMINIUM • ALUMINIUM SNAP-HOOK



5x50 mm		41912	1	12	1,016
6x60 mm		41913	1	12	1,058

**MOSQUETÓN BOMBERO**

MOUSQUETON POMPIER • FIREMAN SNAP-HOOK



40 mm	ZINCADO	41791	4	12	2,023
60 mm	ZINCADO	41792	2	12	1,233
80 mm	ZINCADO	41793	1	12	1,192

**MOSQUETÓN CON MUELLE**

MOUSQUETON À RESSORT  
SPRING-LOADED SNAP-HOOK



MEDIDA	ACABADO	REF.	N° PIEZAS	UDS. EMBALAJE	PRECIO TARIFA
75 mm	NIQUELADO	41914	1	12	2,294

**MOSQUETÓN CON TORNQUETE**

MOUSQUETON À TOURET  
SNAP-HOOK WITH TURNBUCKLE



20 mm	NIQUELADO	41798	3	12	1,031
40 mm	NIQUELADO	41800	2	12	0,948
50 mm	NIQUELADO	41915	2	12	1,051

**MOSQUETÓN**

MOUSQUETON • SNAP-HOOK



3/4	NIQUELADO	41797	1	12	1,497
-----	-----------	-------	---	----	-------

**MOSQUETÓN CIERRE GATILLO**

MOUSQUETON FERMETURE GACHETTE  
TRIGGER LOCK SNAP-HOOK



71 mm	ZINCADO	45987	1	12	1,697
-------	---------	-------	---	----	-------

**MOSQUETÓN DE PINZA**

MOUSQUETON À PINCE • CLAW SNAP-HOOK



50 mm	ZINCADO	45752	1	12	1,310
-------	---------	-------	---	----	-------

**ESLABÓN CON TUERCA**

MAILLON • LINK WITH NUT



3,5 cm	ZINCADO	41794	4	12	1,724
5 cm	ZINCADO	41795	2	12	1,355
6 cm	ZINCADO	41796	1	12	1,030

**ABRAZADERA SIN FIN**

COLLIER DE SERRAGE • HOSE CLAMP



10X17 mm		41923	2	12	1,737
12X20 mm		41924	2	12	1,761
16X25 mm		41925	2	12	1,795
20X32 mm		41926	2	12	1,838
25X40 mm		41927	2	12	1,854
32X50 mm		41928	2	12	1,947

• GALVANIZADO | GALVANISÉE | GALVANIZED • SURTIDO | ASSOTI | ASSORTMENT  
• NIQUELADO | NICKELÉ | NICKEL-PLATED • ZINCADO | ZINGUÉ | ZINC PLATED





MEDIDA: DIMENSION / SIZE | ACABADO: FINITION / FINISH | Nº PIEZAS: Nº PCS / Nº PCS | UDS. EMBALAJE: U.C. / PACKING | PRECIO TARIFA: PRIX / PRICE

### CINTA PERSIANA

SANGLE VOLET ROULANT • BLIND TAPE



MEDIDA	ACABADO	REF.	Nº PIEZAS	UDS. EMBALAJE	PRECIO TARIFA
6 m x 22 mm	GRIS C/BLANCO	45712	1	12	3,262
6 m x 22 mm	MARRÓN	45764	1	12	3,262
6 m x 14 mm	BLANCO P/NEGRA	45765	1	12	2,998
6 m x 18 mm	BLANCO P/NEGRA	45766	1	12	3,142

### TOPE PERSIANA

BUTEE VOLET ROULANT • BLIND END CAPS



40 mm	MARFIL	45713	2	12	1,567
40 mm	BLANCO	45714	2	12	1,567
40 mm	MARRÓN	45767	2	12	1,567
60 mm	MARFIL	45768	2	12	2,047
60 mm	BLANCO	45769	2	12	2,047
60 mm	MARRÓN	45770	2	12	2,047

### RECOGEDOR ABATIBLE CON CINTA

ENROULEUR A BOITIER EXTERIEUR AVEC SANGLE  
FOLDAWAY SURFACE-MOUNTED WITH TAPE



6 m x 14 mm	BLANCO	45715	1	6	10,614
-------------	--------	-------	---	---	--------

### RECOGEDOR ABATIBLE CON CINTA

ENROULEUR A BOITIER EXTERIEUR AVEC SANGLE  
FOLDAWAY SURFACE-MOUNTED WITH TAPE



6 m x 14 mm	MARRÓN	45771	1	6	12,406
6 m x 14 mm	MARFIL	45772	1	6	12,406

### RECOGEDOR DE COMPACTO FRENTE PLÁSTICO ENCASTRABLE SIN TORNILLO

ENROULEUR AVEC SANGLE ENCASTRABLE SANS VIS  
SURFACE-MOUNTED WITH TAPE WITHOUT SCREW



14 mm	BLANCO	45780	1	6	9,630
18 mm	BLANCO	45781	1	6	9,450

### RECOGEDOR EMBUTIR

ENROULEUR A ENCASTRER  
METAL REEL



MEDIDA	ACABADO	REF.	Nº PIEZAS	UDS. EMBALAJE	PRECIO TARIFA
170 mm	METÁLICO	45716	1	6	8,106
170 mm	PLÁSTICO	45717	1	6	6,648

### PLACA FRENTE RECOGEDOR ALUMINIO

PLAQUE DE PROPRETE ALUMINIUM  
ALUMINIUM BLINDS REEL PLATE



0,5 mm	ALUMINIO NATURAL	45773	1	12	2,170
0,5 mm	BLANCO	45774	1	12	2,170
0,5 mm	BRONCE	45775	1	12	3,002

### TIRANTE CON GANCHO

ACCESOIRES VOLET ROULANT  
PLASTIC BRACE WITH HOOK



MIXTO	45776	2	12	2,650
-------	-------	---	----	-------

### CARCASA METÁLICA

SUPPORT VOLET ROULANT  
METALLIC FRAME



CINTA 22 mm	ALUMINIO	45777	1	12	3,859
CINTA 22 mm	BLANCO	45782	1	12	3,859
CINTA 22 mm	BRONCE	45783	1	12	4,691

### GUÍA PARA CINTA

GUIDE POUR SANGLE  
GUIDE FOR TAPE



CINTA 22 mm	PLÁSTICO	45778	1	12	1,831
-------------	----------	-------	---	----	-------

### GUÍA PARA CINTA

GUIDE POUR SANGLE MÉTALLIQUE  
METALLIC GUIDE FOR TAPE



CINTA 22 mm	METÁLICO	45779	1	12	2,203
-------------	----------	-------	---	----	-------

• ALUMINIO | ALUMINIUM | ALUMINIUM  
• BLANCO | BLANC | WHITE  
• BRONCE | BRONZE | BRONZE

• GRIS | GRIS | GREY  
• MARFIL | IVOIRE | IVORY  
• MARRÓN | MARRON | BROWN

• METÁLICO | MÉTALLIQUE | METALLIC  
• NEGRO | NOIR | BLACK  
• PLÁSTICO | PLASTIQUE | PLASTIC



MEDIDA: DIMENSION / SIZE | ACABADO: FINITION / FINISH | N° PIEZAS: N° PCS / N° PCS | UDS. EMBALAJE: U.C. / PACKING | PRECIO TARIFA: PRIX / PRICE

**PERFIL 1/2 CAÑA ADHESIVO**

BARRE DE SEUIL 1/2 ROND ADHESIVE  
ADHESIVE PROFILE 1/2 ROUND

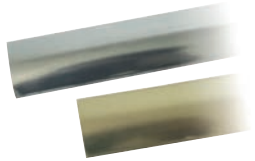

MEDIDA	ACABADO	REF.	N° PIEZAS	UDS. EMBALAJE	PRECIO TARIFA
30 mm	ACERO	41919	1	12	4,293
30 mm	ROBLE	41880	1	12	6,039
30 mm	SAPELY	41882	1	12	6,039
30 mm	LATONADO	45498	1	12	5,536

**PERFIL CERÁMICA ADHESIVO**

BARRE DE SEUIL CERAMIQUE ADHESIVE  
ADHESIVE CERAMIC PROFILE



40 mm	ACERO	41883	1	12	5,476
40 mm	ROBLE	41916	1	12	7,250
40 mm	LATÓN	45986	1	12	11,210
40 mm	SAPELY	41920	1	12	7,250

**REJILLA VENTILACIÓN ALUMINIO**

GRILLE DE VENTILATION ALUMINIUM  
ALUMINIUM VENTILATION GRATE



MEDIDA	ACABADO	REF.	N° PIEZAS	UDS. EMBALAJE	PRECIO TARIFA
10x20 cm	SATINADO	41929	1	10	1,421
10x20 cm	BLANCO	41930	1	10	2,154
15x15 cm	SATINADO	41931	1	10	1,462
15x15 cm	BLANCO	41932	1	10	2,235
20x20 cm	SATINADO	41933	1	10	2,439
20x20 cm	BLANCO	41934	1	10	3,400

**REJILLA DE VENTILACIÓN METÁLICA EMPOTRABLE**

GRILLE DE VENTILATION MÉTALLIQUE ENCASTRABLE  
RECESSED METAL VENTILATION GRATE



15x15 cm	BLANCO	41935	1	10	6,673
----------	--------	-------	---	----	-------

**RUEDAS CON PLETINA**

ROULETTES À PLATINE  
CASTORS WHEELS WITH SWIVEL PLATE



30 mm	NEGRO	45703	4	12	7,493
40 mm	NEGRO	45704	4	12	6,864
50 mm	NEGRO	45705	2	6	4,980

- ACERO | ACIER | STEEL
- BLANCO | BLANC | WHITE
- LATÓN | LAITON | SOLID BRASS
- NEGRO | NOIR | BLACK
- ROBLE | CHÊNE | OAK
- SAPELY | SAPELLI | SAPELLY
- SATINADO | SATINE | SATIN



MEDIDA: DIMENSION / SIZE | ACABADO: FINITION / FINISH | Nº PIEZAS: Nº PCS / Nº PCS | UDS. EMBALAJE: U.C. / PACKING | PRECIO TARIFA: PRIX / PRICE

**TOPE ADHESIVO TORNEADO MADERA**

BUTÉE DE PORTE  
TOURNAGE ADHÉSIVE  
ADHESIVE TURNER  
DOOR STOP



MEDIDA	ACABADO	REF.	Nº PIEZAS	UDS. EMBALAJE	PRECIO TARIFA
	HAYA	41936	1	12	2,496
	NOGAL	41937	1	12	2,496

**TOPE ADHESIVO OVALADO MADERA**

BUTÉE DE PORTE  
OVALE ADHÉSIVE  
ADHESIVE OVAL  
DOOR STOP



	HAYA	41939	1	12	2,906
	NOGAL	41940	1	12	2,906

**TOPE ADHESIVO PLANO MADERA**

BUTÉE DE PORTE  
PLAT ADHÉSIVE  
ADHESIVE FLAT  
DOOR STOP



	HAYA	45995	1	12	2,007
	NOGAL	45996	1	12	2,007

**TOPE DE PUERTA MADERA**

BUTÉE DE PORTE  
BOIS  
WOOD DOOR  
STOP



40 mm	HAYA	41851	1	12	2,134
-------	------	-------	---	----	-------

**TOPE DE PUERTA MADERA**

BUTÉE DE PORTE  
BOIS  
WOOD DOOR  
STOP



60 mm	HAYA	45753	1	12	2,562
-------	------	-------	---	----	-------

**TOPE ADHESIVO TIPO TACO METACRILATO**

BUTÉE DE PORTE  
METHACRYLATE PLUG  
ADHÉSIVE  
METHACRYLATE  
ADHESIVE DOOR STOP



	TRANSPARENTE	41944	1	12	4,861
--	--------------	-------	---	----	-------

**TOPE ADHESIVO OVALADO METACRILATO**

BUTÉE DE PORTE  
OVALE METHACRYLATE  
ADHÉSIVE  
METHACRYLATE  
ADHESIVE OVAL DOOR



	TRANSPARENTE	41961	1	12	4,666
--	--------------	-------	---	----	-------

**TOPE ADHESIVO PLANO METACRILATO**

BUTÉE DE PORTE  
PLATE METHACRYLATE  
ADHÉSIVE  
METHACRYLATE  
ADHESIVE FLAT DOOR  
STOP



	TRANSPARENTE	41943	1	12	4,744
--	--------------	-------	---	----	-------

**TOPE RETENEDOR CON IMAN ADHESIVO**

BUTÉE DE PORTE  
ADHÉSIVE AVEC  
AIMANT  
ADHESIVE MAGNETIC  
DOOR STOP



	BLANCO	41958	1	12	4,384
	MARRÓN	41959	1	12	4,384

**TOPE ADHESIVO DE ACERO Y GOMA**

BUTÉE DE PORTE  
METAL CAOUTCHOUC  
ADHÉSIVE  
RUBBER AND STEEL  
ADHESIVE DOOR STOP



	BLANCO	41964	1	12	4,431
	BEIGE	41965	1	12	4,431
	MARRÓN	41966	1	12	4,431
	DORADO	41967	1	12	7,246
	CROMADO	41968	1	12	5,995

**TOPE DE PUERTA**

BUTÉE DE PORTE  
DOOR STOP



30 mm	LATONADO	41741	1	12	2,246
-------	----------	-------	---	----	-------

**TOPE ADHESIVO BASE INOX**

BUTÉE DE PORTE  
ADHÉSIVE AVEC  
BASE INOX  
ADHESIVE STOP  
DOOR WITH INOX  
BASE



40x40 mm	BLANCO	41945	1	12	1,187
40x40 mm	MARRÓN	41946	1	12	1,187
40x40 mm	BEIGE	41947	1	12	1,187
40x40 mm	BLANCO	41948	2	12	1,739
40x40 mm	MARRÓN	41949	2	12	1,739
40x40 mm	BEIGE	41950	2	12	1,739
40x40 mm	BLANCO	41951	4	12	3,145
40x40 mm	MARRÓN	41952	4	12	3,145
40x40 mm	NEGRO	41953	4	12	3,145
40x40 mm	GRIS	41955	4	12	3,145

- BEIGE | BEIGE | BEIGE
- BLANCO | BLANC | WHITE
- CROMADO | CHROMAGE | CROME PLATED

- DORADO | DORÉ | GOLDEN
- GRIS | GRIS | GREY
- HAYA | HÊTRE | BEECH

- LATÓN | LAITON | SOLID BRASS
- MARRÓN | MARRON | BROWN
- NEGRO | NOIR | BLACK

- NOGAL | NOYER | WALNUT
- TRANSPARENTE | TRANSPARENT | TRANSPARENT



MEDIDA: DIMENSION / SIZE | ACABADO: FINITION / FINISH | N° PIEZAS: N° PCS / N° PCS | UDS. EMBALAJE: U.C. / PACKING | PRECIO TARIFA: PRIX / PRICE

**TOPE CON TACO Y TORNILLO**

BUTÉE DE PORTE AVEC CHEVILLE ET VIS  
DOOR STOP WITH PAD AND SCREW



MEDIDA	ACABADO	REF.	N° PIEZAS	UDS. EMBALAJE	PRECIO TARIFA
	MARRÓN	41973	2	12	1,193

**TOPE DE PUERTA DE GOMA**

BUTÉE DE PORTE CAOUTCHOUC  
RUBBER DOOR STOP



20 mm	BLANCO	41738	2	12	1,002
30 mm	BLANCO	41739	1	12	0,661
40 mm	BLANCO	41740	1	12	1,820

**TOPE DE PUERTA DE GOMA ALTO**

BUTÉE DE PORTE CAOUTCHOUC HAUT  
RUBBER HIGH DOOR STOP



30 mm	BLANCO	45754	1	12	0,896
-------	--------	-------	---	----	-------

**TOPE DE PUERTA PARA SUELOS**

BUTÉE DE PORTE POUR SOL  
DOOR STOP FOR FLOORS



30 mm	MARRÓN	45755	1	12	0,666
30 mm	BLANCO	45756	1	12	0,666
22 mm	MARRÓN	45758	2	12	0,787
22 mm	BLANCO	45759	2	12	0,787
22 mm	ROBLE	45760	2	12	0,787

• BLANCO | BLANC | WHITE  
• MARRÓN | MARRON | BROWN

• ROBLE | CHÊNE | OAK  
• TRANSPARENTE | TRANSPARENT | TRANSPARENT

**TOPE PROTECTOR DE PVC**

BUTÉE DE PORTE EN PVC  
PVC STOP PROTECTOR



MEDIDA	ACABADO	REF.	N° PIEZAS	UDS. EMBALAJE	PRECIO TARIFA
15x15 mm	MARRÓN	41977	1	12	1,539
15x15 mm	BLANCO	41978	1	12	1,539
20x20 mm	MARRÓN	41979	1	12	1,539
20x20 mm	BLANCO	41980	1	12	1,539

**GOTA PROTECTORA ADHESIVA**

BUTÉE ADHESIVE  
PROTECTOR ADHESIVE DROP



10x3 mm	TRANSPARENTE	41981	25	12	1,374
10x1,5 mm	TRANSPARENTE	41982	25	12	1,464

**TOPE RETENEDOR TIPO CUNA**

BUTÉE CALE • WEDGE TYPE RETAINER STOP



13x19x50 mm	MARRÓN	41975	1	12	0,757
15X19X50 mm	BLANCO	45761	2	12	1,072
13x19x50 mm	MARRÓN	45762	2	12	1,072

**TOPE RETENEDOR GIRATORIO ADHESIVO CON TORNILLO**

BUTOIR RETENEUR ADHESIVE AVEC VIS  
ADHESIVE ROTATION RETAINER WITH SCREW



	MARRÓN	41960	1	12	2,530
--	--------	-------	---	----	-------



MEDIDA: DIMENSION / SIZE | ACABADO: FINITION / FINISH | Nº PIEZAS: Nº PCS / Nº PCS | UDS. EMBALAJE: U.C. / PACKING | PRECIO TARIFA: PRIX / PRICE

**ANTIDESLIZANTE CAUCHO REDONDO**

PATIN ANTIDERAPANT ROND  
RUBBER MADE ROUND ANTI-SLIP

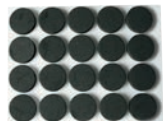

MEDIDA	ACABADO	REF.	Nº PIEZAS	UDS. EMBALAJE	PRECIO TARIFA
16 mm	NEGRO	41983	20	10	0,660

**ANTIDESLIZANTE CAUCHO CUADRADO**

PATIN ANTIDERAPANT CARRE  
RUBBER MADE SQUARE ANTI-SLIP

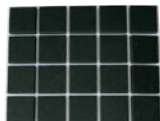

MEDIDA	ACABADO	REF.	Nº PIEZAS	UDS. EMBALAJE	PRECIO TARIFA
17x17 mm	NEGRO	41984	20	10	0,680

**ANTIDESLIZANTE CAUCHO RECTANGULAR**

PATIN ANTIDERAPANT A DECOUPER  
RUBBER MADE RECTANGULAR ANTI-SLIP



MEDIDA	ACABADO	REF.	Nº PIEZAS	UDS. EMBALAJE	PRECIO TARIFA
105x80 mm	BLANCO	41985	2	10	0,828
105x80 mm	NEGRO	41986	2	10	0,828

**PATÍN FIELTRO**

PATIN AMORTISSEUR A POINTE  
FELT PAD WITH NAIL



MEDIDA	ACABADO	REF.	Nº PIEZAS	UDS. EMBALAJE	PRECIO TARIFA
17 mm		41987	8	10	1,111
20 mm		41718	8	10	1,125
24 mm		41719	4	10	0,972
28 mm		41720	4	10	1,056

**PATÍN AMORTIGUADOR CON PUNTA**

PATIN AMORTISSEUR A POINTE  
DAMPING PAD WITH POINT



MEDIDA	ACABADO	REF.	Nº PIEZAS	UDS. EMBALAJE	PRECIO TARIFA
18 mm	NIQUELADO	41727	6	10	1,794
23 mm	NIQUELADO	41728	4	10	1,498
30 mm	NIQUELADO	41729	4	10	1,832

• BLANCO | BLANC | WHITE  
• MARRÓN | MARRON | BROWN

• NEGRO | NOIR | BLACK  
• NIQUELADO | NICKELÉ | NICKEL-PLATED

**TOPE DE SILLA CON PUNTA**

TAQUET DE CHAISE • CHAIR BUFFER WITH POINT



MEDIDA	ACABADO	REF.	Nº PIEZAS	UDS. EMBALAJE	PRECIO TARIFA
12 mm	MARRÓN	41832	6	10	1,016
12 mm	BLANCO	41833	6	10	1,016
16 mm	MARRÓN	41834	6	10	1,070
16 mm	BLANCO	41835	6	10	1,070

**PATÍN TEFLÓN REDONDO**

PATIN GLISSEUR ROND  
ROUND TEFLON ADHESIVE PAD



MEDIDA	ACABADO	REF.	Nº PIEZAS	UDS. EMBALAJE	PRECIO TARIFA
Ø25x5mm		41988	4	10	1,650

**PATÍN TEFLÓN RECTANGULAR**

PATIN GLISSEUR DROIT  
RECTANGULAR TEFLON ADHESIVE PAD



MEDIDA	ACABADO	REF.	Nº PIEZAS	UDS. EMBALAJE	PRECIO TARIFA
25x35x5mm		41989	4	10	1,902

**DESILIZANTE**

PATIN GLISSEUR • SLIDING PADS



MEDIDA	ACABADO	REF.	Nº PIEZAS	UDS. EMBALAJE	PRECIO TARIFA
20 mm	BLANCO	41721	8	10	1,387
24 mm	BLANCO	41722	8	10	1,522
30 mm	BLANCO	41723	4	10	1,140
20 mm	MARRÓN	41724	8	10	1,387
24 mm	MARRÓN	41725	8	10	1,522
30 mm	MARRÓN	41726	4	10	1,140



MEDIDA: DIMENSION / SIZE | ACABADO: FINITION / FINISH | N° PIEZAS: N° PCS / N° PCS | UDS. EMBALAJE: U.C. / PACKING | PRECIO TARIFA: PRIX / PRICE

**FIELTRO ADHESIVO REDONDO**

PATIN FEUTRE ADHESIF ROND  
ADHESIVE ROUND FELT



MEDIDA	ACABADO	REF.	N° PIEZAS	UDS. EMBALAJE	PRECIO TARIFA
17x3 mm	BLANCO	41990	1	10	0,680
17x3 mm	MARRÓN	41991	1	10	0,680
22x3 mm	BLANCO	41992	1	10	0,646
22x3 mm	MARRÓN	41993	1	10	0,646
27x3 mm	BLANCO	41994	1	10	0,620
27x3 mm	MARRÓN	41995	1	10	0,620
34x3 mm	BLANCO	41996	1	10	0,620
34x3 mm	MARRÓN	41997	1	10	0,620
17x3 mm	BLANCO	41998	2	10	0,903
17x3 mm	MARRÓN	41999	2	10	0,903
22x3 mm	BLANCO	45800	2	10	0,878
22x3 mm	MARRÓN	45801	2	10	0,878
27x3 mm	BLANCO	45802	2	10	0,768
27x3 mm	MARRÓN	45803	2	10	0,768
34x3 mm	BLANCO	45804	2	10	0,768
34x3 mm	MARRÓN	45805	2	10	0,768

**FIELTRO ADHESIVO CUADRADO**

PATIN FEUTRE ADHESIF CARRE  
ADHESIVE SQUARE FELT BROWN

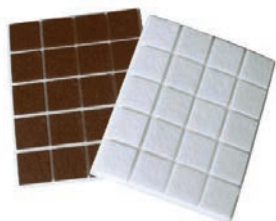

17x17x3 mm	BLANCO	45806	1	10	0,660
17x17x3 mm	MARRÓN	45807	1	10	0,660
22x22x3 mm	MARRÓN	45808	1	10	0,650
17x17x3 mm	BLANCO	45809	2	10	0,873
17x17x3 mm	MARRÓN	45810	2	10	0,873
22x22x3 mm	BLANCO	45811	2	10	0,864
22x22x3 mm	MARRÓN	45812	2	10	0,864

**FIELTRO ADHESIVO RECTANGULAR**

PATIN FEUTRE ADHESIF RECTANGULAIRE  
ADHESIVE RECTANGULAR FELT



29x23x3 mm	BLANCO	45813	1	10	0,660
29x23x3 mm	MARRÓN	45814	1	10	0,660
95x12x3 mm	BLANCO	45815	1	10	0,685
95x12x3 mm	MARRÓN	45816	1	10	0,685
100x85x3 mm	BLANCO	45817	1	10	0,685
100x85x3 mm	MARRÓN	45818	1	10	0,685
29x23x3 mm	BLANCO	45819	2	10	0,818
29x23x3 mm	MARRÓN	45820	2	10	0,818
95x12x3 mm	BLANCO	45821	2	10	0,893
95x12x3 mm	MARRÓN	45822	2	10	0,893
100x85x3 mm	BLANCO	45823	2	10	0,908
100x85x3 mm	MARRÓN	45824	2	10	0,908

- BLANCO | BLANC | WHITE
- MARRÓN | MARRON | BROWN
- NEGRO | NOIR | BLACK

**CONTERA DE GOMA PARA MUEBLE**

PATIN ENVELOPPANT CAOUTCHOUC  
RUBBER WRAP-ROUND PAD



MEDIDA	ACABADO	REF.	N° PIEZAS	UDS. EMBALAJE	PRECIO TARIFA
10 mm	BLANCO	45735	4	10	0,889
12 mm	BLANCO	41857	4	10	0,931
14 mm	BLANCO	41858	4	10	1,066
16 mm	BLANCO	41859	2	10	0,877
18 mm	BLANCO	41860	2	10	0,943
20 mm	BLANCO	41861	2	10	1,029
22 mm	BLANCO	41862	2	10	1,066
25 mm	BLANCO	41863	2	10	1,378

**CONTERA DE GOMA PARA MUEBLE**

PATIN ENVELOPPANT CAOUTCHOUC  
RUBBER WRAP-ROUND PAD



10 mm	NEGRO	45736	4	10	0,889
12 mm	NEGRO	41864	4	10	0,931
14 mm	NEGRO	41865	4	10	1,066
16 mm	NEGRO	41866	2	10	0,877
18 mm	NEGRO	41867	2	10	0,943
20 mm	NEGRO	41868	2	10	1,029
22 mm	NEGRO	41869	2	10	1,066
25 mm	NEGRO	41870	2	10	1,378

**CONTERA PLÁSTICO PARA MUEBLE**

EMBOUT ENVELOPPANT  
FURNITURE FEET PROTECTOR



10 mm	NEGRO	41730	8	10	1,000
12 mm	NEGRO	41731	8	10	1,037
14 mm	NEGRO	41732	8	10	1,140
16 mm	NEGRO	41733	8	10	1,313
18 mm	NEGRO	41734	4	10	1,037
20 mm	NEGRO	41735	4	10	1,108
22 mm	NEGRO	41736	4	10	1,173
25 mm	NEGRO	45734	2	10	0,934



**CORDELERÍA | ALAMBRES**  
CORDAGES / FILES DE FER - ROPES / WIRES

MEDIDA	LONGITUD	TIPO	REF.	N° PIEZAS	UDS. EMBALAJE	PRECIO TARIFA
--------	----------	------	------	-----------	---------------	---------------

**ALAMBRE GALVANIZADO**

FIL DE FER GALVANISE • GALVANIZED WIRE



0,7 mm	75 m	N-2	45862	1	12	2,926
0,9 mm	50 m	N-4	45863	1	12	2,831
1,1 mm	50 m	N-6	45864	1	12	3,208
1,3 mm	40 m	N-8	45865	1	12	3,490

**ALAMBRE PLASTIFICADO**

FIL DE FER PLASTIFIE • PLASTIFICATED WIRE



1 mm	25 m	N-5	45866	1	12	3,255
------	------	-----	-------	---	----	-------



MEDIDA: DIMENSION / SIZE | ACABADO: FINITION / FINISH | Nº PIEZAS: Nº PCS / Nº PCS | UDS. EMBALAJE: U.C. / PACKING | PRECIO TARIFA: PRIX / PRICE

**BOBINA HILO BALA**

FICELLE A EMBALLER • BOBBIN OF PACKING THREAD



MEDIDA	ACABADO	REF.	Nº PIEZAS	UDS. EMBALAJE	PRECIO TARIFA
50 g	2 CABOS	45825	1	12	2,593
100 g	2 CABOS	45826	1	12	3,733

**BOBINA DE RAFIA DE POLIPROPILENO**

RAFIA SYNTHETIQUE POLYPROPYLENE  
BOBBIN OF POLYPROPYLENE

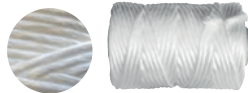

50 m	1 CABO - 1200 m/kg	45827	1	12	2,234
50 m	1 CABO - 600 m/kg	45828	1	12	2,277
120 m	1 CABO	45829	1	6	3,882
75 m	2 CABOS	45830	1	6	3,284

**BOBINA DE POLIPROPILENO**

FICELLE POLYPROPYLENE • BOBBIN OF POLYPROPYLENE



50 m	2 mm	45832	1	12	2,862
100 m	2 mm	45831	1	6	4,865

**CUERDA DE TENDER BICOLOR**

CORDE A LINGE • CLOTHESLINE



10 m	4 mm	45833	1	12	2,518
20 m	4 mm	45834	1	6	3,434

**HILO ACERO PLASTIFICADO**

FIL PLASTIFIE • LAMINATED STEEL THREAD



10 m	3,5 mm AMARILLO	45844	1	12	3,882
20 m	3,5 mm AMARILLO	45845	1	6	5,897
10 m	3,5 mm VERDE	45846	1	12	3,882
20 m	3,5 mm VERDE	45847	1	6	5,897

**BOBINA SISAL**

FICELLE SISAL • BOBBIN OF SISAL



50 m	1 CABO	45835	1	6	3,509
125 m	1 CABO	45836	1	6	7,391
50 m	2 CABOS	45837	1	6	3,621
100 m	2 CABOS	45838	1	6	6,495

**MADEJA DE SISAL**

SISAL • BAIL OF SISAL THREAD



20 m	6 mm	45839	1	6	7,653
------	------	-------	---	---	-------

- AMARILLO | JAUNE | YELLOW
- BLANCO | BLANC | WHITE
- VERDE | VERT | GREEN

**CORDÓN RIEL PLÁSTICO**

CORDE RIDEAU PLASTIQUE • PLASTIC CORD FOR RAILS



MEDIDA	ACABADO	REF.	Nº PIEZAS	UDS. EMBALAJE	PRECIO TARIFA
10 m	2,5 mm	45840	1	12	1,990
20 m	2,5 mm	45841	1	12	3,284

**CORDÓN RIEL POLIPROPILENO**

CORDE RIDEAU POLYPROPYLENE  
POLYPROPYLENE CORD FOR RAILS



10 m	2,5 mm	45842	1	12	1,990
20 m	2,5 mm	45843	1	12	3,284

**CORDÓN TRENZADO NYLON PINTA ROJA**

CORDON TRESSE NYLON • NYLON BRAIDED CORD



20 m	5 mm	45848	1	6	6,495
------	------	-------	---	---	-------

**CORDÓN TRENZADO POLIPROPILENO TRICOLOR**

CORDAGE POLYPROPYLENE TRESSE  
POLYPROPYLENE BRAIDED CORD



10 m	5 mm	45849	1	12	2,518
20 m	5 mm	45850	1	6	4,591

**CORDON TRENZADO NYLON PINTA GRIS**

CORDON TRESSE NYLON • NYLON BRAIDED CORD



10 m	5 mm	45852	1	6	3,284
------	------	-------	---	---	-------

**CORDÓN TRENZADO NYLON**

CORDON TRESSE NYLON • NYLON BRAIDED CORD



10 m	5 mm BLANCO	45853	1	12	3,284
20 m	5 mm BLANCO	45854	1	6	6,495

**ALGODÓN ATADORA**

CORDEAU COTON • RAW COTTON FOR TYING



275 m	1 CABO BLANCO	45725	1	6	5,475
-------	---------------	-------	---	---	-------



MEDIDA: DIMENSION / SIZE | ACABADO: FINITION / FINISH | Nº PIEZAS: Nº PCS / Nº PCS | UDS. EMBALAJE: U.C. / PACKING | PRECIO TARIFA: PRIX / PRICE

MEDIDA	ACABADO	REF.	Nº PIEZAS	UDS. EMBALAJE	PRECIO TARIFA
25 mm	NIQUELADO	45970	1	12	2,642
35 mm	NIQUELADO	45971	1	6	3,782
45 mm	NIQUELADO	45972	1	6	5,422

**CANDADO**

CADENAS A CLE  
PADLOCK



**CANDADO DOBLE CIERRE**

CADENAS A CLE  
SECURITE LAITON  
BRASS PADLOCK  
DOUBLE LOCK



30 mm	LATÓN	45980	1	12	5,303
40 mm	LATÓN	45981	1	6	7,688
50 mm	LATÓN	45982	1	6	12,589
60 mm	LATÓN	45983	1	6	18,108

**CANDADO ARCO LARGO**

CADENAS ANSE LONGUE  
LONG SHACKLE PADLOCK



40 mm	LATÓN	45976	1	6	7,979
-------	-------	-------	---	---	-------

**CANDADO COMBINACIÓN  
PARA MALETAS**

CADENAS A CODAGE  
CHIFFRE  
COMBINATION PADLOCK  
FOR TRAVEL BAGS



20 mm	LATÓN	45984	1	12	7,189
30 mm	LATÓN	45985	1	6	11,192

**CANDADO COMBINACIÓN  
CIRCULAR**

CADENAS A  
CODAGE CHIFFRE  
CIRCULAR  
COMBINATION  
PADLOCK



		45977	1	12	2,642
--	--	-------	---	----	-------

**CANDADO COMBINACIÓN  
LLAVERO**

CADENAS A CODAGE  
CHIFFRE  
KEYRING COMBINATION  
PADLOCK



		45978	1	12	2,642
--	--	-------	---	----	-------

**CANDADO DISCO DE ACERO**

CADENAS A CLE ROND • PADLOCK



70 mm	INOX	45979	1	6	12,632
-------	------	-------	---	---	--------

- BLANCO | BLANC | WHITE
- GRIS | GRIS | GREY
- INOXIDABLE | INOXIDABLE | STAINLESS STEEL
- LATÓN | LAITON | SOLID BRASS
- NEGRO | NOIR | BLACK
- NIQUELADO | NICKELÉ | NICKEL-PLATED



MEDIDA	ACABADO	REF.	Nº PIEZAS	UDS. EMBALAJE	PRECIO TARIFA
100x2,5 mm	BLANCO	45901	25	10	0,992
100x2,5 mm	NEGRO	45902	25	10	0,992
140x2,5 mm	BLANCO	45903	25	10	1,223
140x2,5 mm	NEGRO	45904	25	10	1,223
200x3,6 mm	BLANCO	45905	25	10	1,859
200x3,6 mm	NEGRO	45906	25	10	1,859
300x4,5 mm	BLANCO	45907	25	10	3,243
300x4,5 mm	NEGRO	45908	25	10	3,243

**BRIDA NYLON**  
(EN BOLSA CON ZIPPER)

COLLIERS NYLON • CABLE TIE NYLON



MEDIDA	ACABADO	REF.	Nº PIEZAS	UDS. EMBALAJE	PRECIO TARIFA
200x200 mm	BLANCO	45869	1	10	2,368
300x300 mm	BLANCO	45870	1	10	3,072
400x400 mm	BLANCO	45871	1	10	3,698

**PALOMILLA PLEGABLE**

CONSOLE PLIABLE • FOLDING BRACKET



**PALOMILLA REFORZADA**

CONSOLE RENFORCEE • REINFORCED BRACKET



125x200 mm	BLANCO	45893	1	10	2,478
200x250 mm	BLANCO	45873	1	10	3,236
300x200 mm	BLANCO	45874	1	10	3,672
400x250 mm	BLANCO	45875	1	10	4,832
500x330 mm	BLANCO	45876	1	10	6,217

**PALOMILLA CON NERVI**

CONSOLE • SHELF BRACKET



100x75 mm	BLANCO	45877	1	20	0,287
125x100 mm	BLANCO	45878	1	20	0,353
150x125 mm	BLANCO	45879	1	20	0,431
200x150 mm	BLANCO	45880	1	20	0,635
250x200 mm	BLANCO	45881	1	20	0,909
300x250 mm	BLANCO	45882	1	20	1,300
300x350 mm	BLANCO	45718	1	20	1,818
100x75 mm	GRIS	45884	1	20	0,287
125x100 mm	GRIS	45885	1	20	0,353
150x125 mm	GRIS	45886	1	20	0,431
200x150 mm	GRIS	45887	1	20	0,635
250x200 mm	GRIS	45888	1	20	0,909
300x250 mm	GRIS	45889	1	20	1,300
300x350 mm	GRIS	45719	1	20	1,818



**FER.**

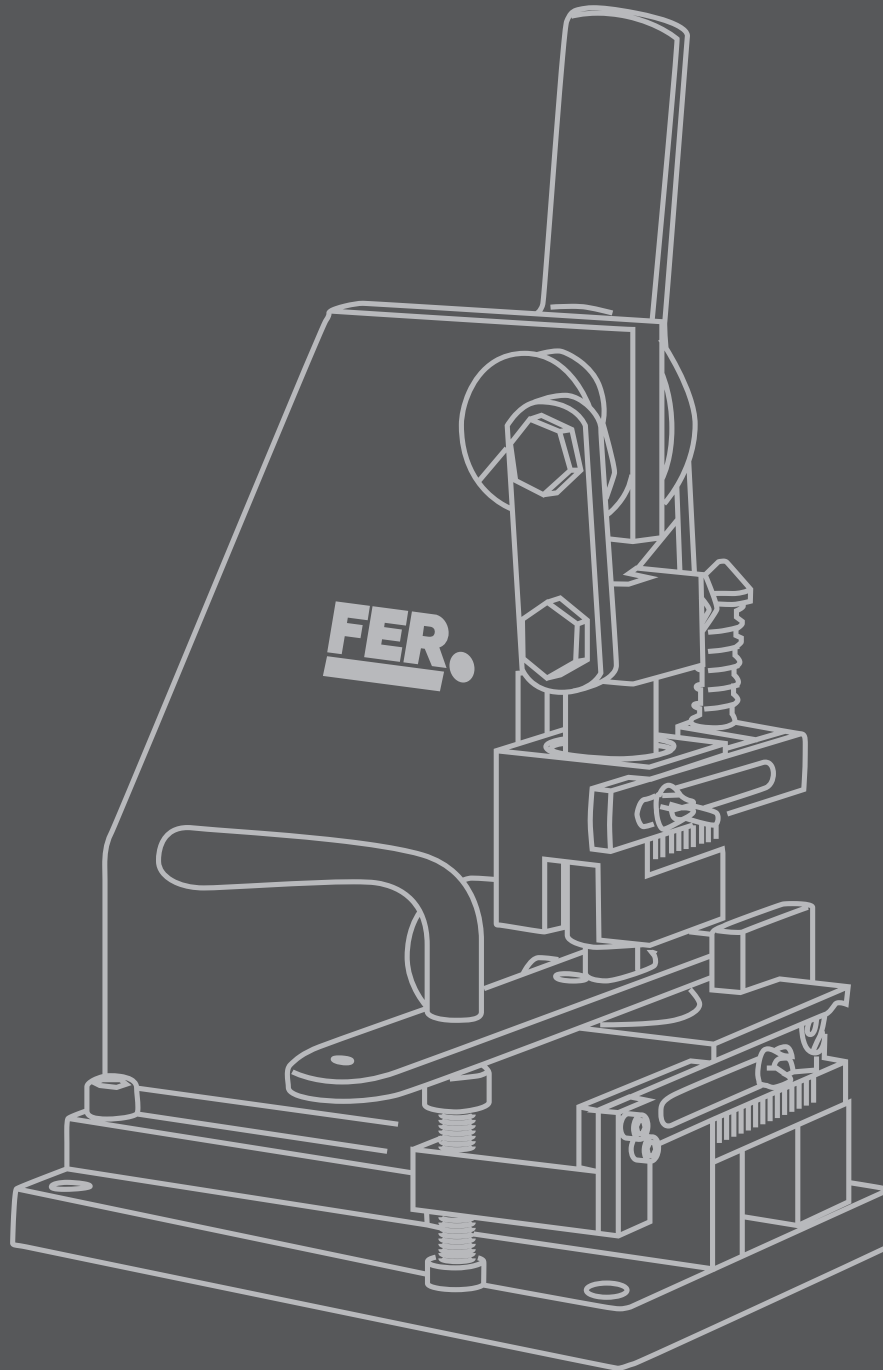

**MÁQUINAS  
BOCALLAVES**  
MACHINES TROU DE CLEF /  
KEYWAY MACHINES



ES

Máquinas para realizar todo tipo de bocallave en manillas estándar o de placa ancha.

FR

Machines pour faire toute sorte de trou de clef, plaques étroites ou larges.

EN

Machines for the production of any type of keyway, narrow or large plates.

**BOCAPRENS 901**

**BOCAPRENS MECÁNICA CON 4 JUEGOS DE UTILLAJES (2 de forma y 2 redondos)**

FR: Machine avec 4 outillages, 2 forme (modèle 1-10) et 2 ronde (modèle 11 n'importe quelle diamètre).

EN: Machine with 4 coupe of devices, 2 form (model 1-10) and 2 round (model 11 any diameter).



VOLUMEN DE USO	MODERADO
REF.	901
PRECIO NETO	1.998 €

**BOCAPRENS 902**

**BOCAPRENS ELÉCTRICA CON 4 JUEGOS DE UTILLAJES (2 de forma y 2 redondos)**

FR: Machine électrique pour plaque étroite avec 4 outillages, 2 forme (modèle 1-10) et 2 ronde (modèle 11 n'importe quelle diamètre).

EN: Electrical machine for narrow plates. This model substitute the manual one to get better performance and service. Machine with 4 coupe of devices, 2 form (model 1-10) and 2 round (model 11 any diameter).



VOLUMEN DE USO	INTENSIVO
REF.	902
PRECIO NETO	2.950 €

**BOCAPRENS 903**

**BOCAPRENS ELÉCTRICA PARA PLACA ANCHA CON 4 JUEGOS DE UTILLAJES (2 de forma, uno de ellos de pera especial inox y 2 redondos)**

FR: Machine électrique pour plaque étroite et large avec 4 outillages, 2 forme (modèle 1-10, un pour inox) et 2 ronde (modèle 11 n'importe quelle diamètre).

EN: Electrical machine for narrow and large plates. Machine with 4 coupe of devices, 2 form (model 1-10, one special stainless steel) and 2 round (model 11 any diameter).



VOLUMEN DE USO	INTENSIVO Y ESPECIAL PARA PLACAS ANCHAS
REF.	903
PRECIO NETO	3.990 €

**INSTRUCCIONES**

ES

FR

EN

1

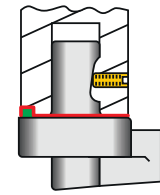

Colocación del punzón: Introducir el punzón haciendo coincidir el pivote rectangular (verde) en su alojamiento, asentar el punzón (rojo), y fijarlo con el prisionero (amarillo).

Mise en place du poinçon : Introduire le poinçon en mettant le pivot rectangulaire (vert) dans son logement, bien asseoir le poinçon (rouge) et fixer le poinçon à l'aide de la vis sans tête (jaune).

Position of punch: Insert the punch in such a way that the rectangular swivel (green) is lined up in its recess, put the punch in place (red), and fit the punch with the setbolt (yellow).

2

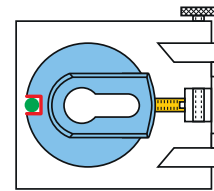

Introducir la matriz (azul) haciendo coincidir la ranura (rojo) con el pitón (verde) y fijar por medio del prisionero (amarillo).

Introduire la matrice (bleu) en faisant coïncider la rainure (rouge) et le piton (vert) puis fixer à l'aide de la vis sans tête (jaune).

Insert the master die (blue) so that the dowel (green) fits into the groove (red) and secure it by means of a setbolt (yellow).

3

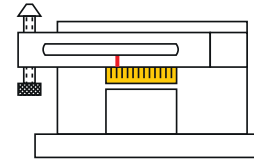

La distancia de la bocallave se regula haciendo coincidir la raya (rojo) con la medida deseada en la escala (amarillo).

La distance du trou de clé se règle en faisant coïncider le trait (rouge) et la mesure souhaitée sur l'échelle (jaune).

The distance of the keyway can be set by lining up the line (red) with the required measurement on the scale (yellow).

4

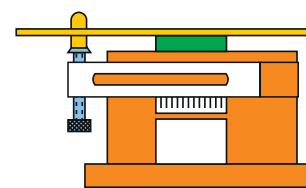

Colocación de la placa:  
1. Introducir el cuadradillo de la manilla (amarillo) en el tornillo con extremo cónico (azul).  
2. Asentar la placa sobre la matriz (verde). Girar el tornillo (azul) hasta que la placa (amarillo) quede paralela a la mesa (naranja).

Mise en place de la plaque:  
1. Introduire le carré de la poignée (jaune) dans la vis à extrémité conique (bleu).  
2. Asseoir la plaque sur la matrice (vert). Faire tourner la vis (bleu) jusqu'à ce que la plaque (jaune) soit parallèle à la table (orange).

Positioning of the plate:  
1. Insert the square bar of the knob (yellow) in the taperbolt (blue).  
2. Place the plate over the master die (green). Turn the bolt (blue) until the plate (yellow) is parallel with the table (orange).

5

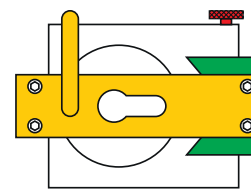

Para realizar la bocallave en el centro de la placa, girar la tuerca (rojo) hasta que las mordazas (verde) centren la placa (no es necesario apretar).

Pour faire le trou de clef au centre de la plaque, faire tourner l'écrou (rouge) jusqu'à ce que les mâchoires (vert) centrent la plaque (il n'est pas nécessaire de serrer).

To make the keyway in the centre of the plate, turn the nut (red), until the clamp (green) aligns the piece in the centre (it is not necessary to tighten).

6

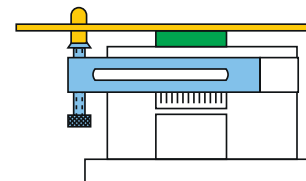

Para realizar un corte perfecto, la placa (amarillo) debe asentar sobre la matriz (verde). En el caso de que no asiente correctamente, quitar la escuadra con tornillo inferior (azul) y colocar la escuadra superior para realizar la bocallave al revés.

Pour effectuer une coupe parfaite, la plaque (jaune) doit être bien assise sur la matrice (vert). Si elle n'est pas correctement en place, retirer l'équerre à vis inférieure (bleu) et mettre l'équerre supérieure pour faire le trou de clé.

To perform a perfect cut, the plate (yellow) should rest over the master die (green). If it does not fit correctly remove the square with the lower bolt (blue) and fit the upper square to make the keyway the other way round.



ES  
Todos los utillajes sirven para las Bocaprens modelos 901, 902 y 903.

FR  
Tous les outillages servent pour les Bocaprens 901,902 et 903.

EN  
All devices are suitable for the Bocaprens 901,902 and 903.

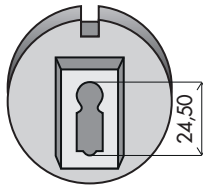
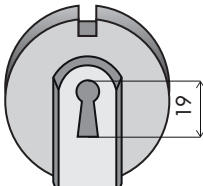
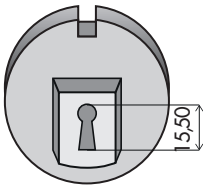
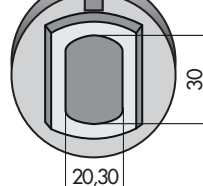
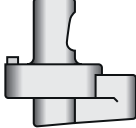
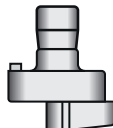
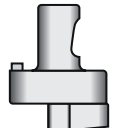
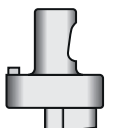
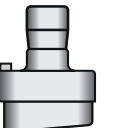
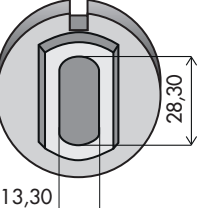
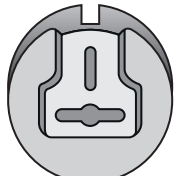
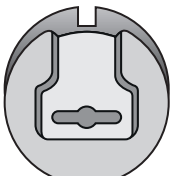
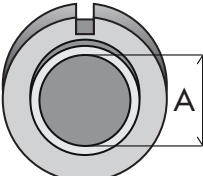
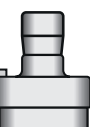
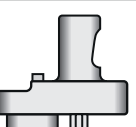
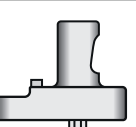
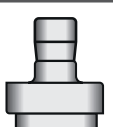
REF.	PRECIO NETO	REF.	PRECIO NETO	REF.	PRECIO NETO	REF.	PRECIO NETO	REF.	PRECIO NETO
<b>MATRIZ PERA</b>		<b>MATRIZ BORJA ALEMANA</b>		<b>MATRIZ BORJA ESPAÑOLA</b>		<b>MATRIZ BORJA TIRADOR ARMARIO</b>		<b>MATRIZ OVALADA</b>	
M0 ESPECIAL INOX	225 €	M2	115 €	M5	115 €	M6	115 €	M7	115 €
M1	115 €								
<b>PUNZÓN PERA</b>		<b>PUNZÓN BORJA ALEMANA</b>		<b>PUNZÓN BORJA ESPAÑOL</b>		<b>PUNZÓN BORJA TIRADOR ARMARIO</b>		<b>PUNZÓN OVALADO</b>	
P1	115 €	P2	115 €	P5	115 €	P6	115 €	P7	115 €
									
<b>MATRIZ OVALADA</b>		<b>MATRIZ DOBLE PALA CON CORREDERA</b>		<b>MATRIZ DOBLE PALA</b>		<b>MATRIZ REDONDA</b>			
M8	115 €	M9	115 €	M10	115 €	M11	75,00 €		
							A: (8,50) (9,30) (10,35) (11,20) (11,85) (13) (14) (15) (16) (17) (18) (19) (20,35) (22,30) (25,50) (26,50) (28,35) (30,60) (32)		
<b>PUNZÓN OVALADO</b>		<b>PUNZÓN DOBLE PALA CON CORREDERA</b>		<b>PUNZÓN DOBLE PALA</b>		<b>PUNZÓN REDONDO</b>			
P8	115 €	P9	115 €	P10	115 €	P11	43,50 €		
									

## PORTES

La elección del medio de transporte será por cuenta de INDUSTRIAS FER, S.L.

- A)** Península y Baleares (Mallorca y Menorca); los envíos se realizarán a portes pagados para pedidos superiores a 240 Euros/Neto. En el caso en que el pedido sea de importe inferior, Industrias Fer, S.L. realizará el envío a portes pagados cargando el importe de los mismos en factura.
- B)** Canarias, Ceuta, Melilla, Ibiza y Formentera; las condiciones son F.O.B. a partir de un importe de 600 Euros el pedido se despachará C.I.F.
- C)** Los pedidos inferiores a 100 Euros/Neto, sufrirán un recargo de un 10%

## PLAZO DE ENTREGA

La mercancía será servida en función de las circunstancias del pedido (número de unidades y clase de la referencia solicitada) y de las disponibilidades de INDUSTRIAS FER, S.L. en el momento. Si el cliente precisa que la entrega se realice en un plazo determinado deberá ponerlo expresamente en el pedido, no habiendo lugar a ninguna reclamación por retraso en la entrega, salvo que expresamente se pacte otra cosa.

## RECLAMACIONES

Si existiera alguna disconformidad, en la entrega de algún pedido enviado por Industrias Fer, S.L. el cliente deberá ponerlo de manifiesto, bien rechazando la mercancía, si su disconformidad es total, bien recibéndola parcialmente, y haciendo constar en el albarán de entrega su queja en cuanto al producto rechazado en el caso de disconformidad parcial. La firma del albarán de entrega sin salvedad alguna, supondrá la aceptación de la mercancía y la conformidad del cliente en cuanto a la cantidad y referencias servidas, no admitiéndose ningún tipo de reclamación una vez transcurridos 15 días desde la entrega del pedido.

## DEVOLUCIÓN DEL MATERIAL

No se admitirán devoluciones de material transcurridos 15 días desde la fecha de entrega del material. En caso de devolución justificada tendrá que consultarse por escrito a INDUSTRIAS FER, S.L. para su aceptación y concretar el medio de transporte y agencia. El importe de la devolución será descontado en la próxima factura.

## CONDICIONES DE PAGO

La transmisión de la propiedad de la mercancía a favor del cliente no tendrá lugar hasta que se haya completado el pago de su precio. En el supuesto en que llegado el vencimiento del pago, éste no se haya efectuado por el cliente, INDUSTRIAS FER, S.L. tendrá la facultad alternativa de exigir el pago del precio con sus intereses o la devolución de la mercancía.

El plazo y forma de pago habitual será giro a 60 días.

Hay un descuento de un 0,5% para giros a 30 días.

## GARANTÍAS

INDUSTRIAS FER, S.L. garantiza sus productos contra cualquier defecto de fabricación, sin responsabilizarse de la utilización inadecuada de los mismos. En cualquier caso nuestra responsabilidad estará limitada al valor del material suministrado. Nos reservamos el derecho de modificar, sin previo aviso, las características inherentes de nuestros productos.

## IMPUESTOS

Los precios están sujetos al impuesto sobre el valor añadido, siendo a cargo del cliente el recargo correspondiente.









**VISITA NUESTRO  
CATÁLOGO ONLINE**

CONSULTEZ NOTRE CATALOGUE EN LIGNE  
CONSULT OUR ONLINE CATALOGUE



Polígono Industrial Mendiola, 16  
20590 - PLACENCIA (Guipúzcoa)

Tel.: 943 75 20 00

Telefax: 943 75 19 80

E-mail: [comercial@industriasfer.com](mailto:comercial@industriasfer.com)

[www.industriasfer.com](http://www.industriasfer.com)

**VISUALIZA NUESTRO  
VÍDEO DE PRESENTACIÓN**

VISUALISEZ NOTRE VIDÉO DE PRÉSENTATION  
DISPLAY OUR INTRODUCTORY VIDEO

